

# PORT OF BROOKINGS HARBOR

## Special Commissioner Meeting

16350 Lower Harbor Rd Suite 202

Thursday, July 30, 2020 • 3:00pm

Teleconference / Meeting Room (Limited Space)

---

**Teleconference Call-In Number: 1 (301) 715-8592**

**Meeting ID: 831 0030 9065    Participant ID: #                    (to mute/unmute: \* 6)**

*When calling in, please announce your arrival and state your name when you join the meeting.*

---

## TENTATIVE AGENDA

### 1. CALL MEETING TO ORDER

- Roll Call
- Modifications, Additions, and Changes to the Agenda
- Declaration of Potential Conflicts of Interest

### 2. APPROVAL OF AGENDA

### 3. PUBLIC COMMENTS (Limited to a maximum of three minutes per person. Please email your comments to [danielle@portofbrookingsharbor.com](mailto:danielle@portofbrookingsharbor.com) prior to the meeting. \*\*\*Please wait to be called on before speaking\*\*\*)

### 4. ACTION ITEMS

- A. Procurement Approval for Sealcoating and Striping Boat Launch Parking Lot
- B. Procurement Approval for Port Office Copier

### 5. INFORMATION ITEMS

- A. None

### 6. COMMISSIONER COMMENTS

### 7. NEXT REGULAR MEETING DATE – Tuesday, August 18, 2020 at 6:00pm

### 8. ADJOURNMENT

A request for an interpreter for the hearing impaired, for those who want to participate but do not have access to a telephone, or for other accommodations for persons with disabilities should be made at least 48 hours in advance of the meeting to Port of Brookings Harbor Office at 541-469-2218.

# ACTION ITEM – A

---

**DATE:** July 30, 2020  
**RE:** Sealcoating Boat Launch Ramp Parking Lot  
**TO:** Honorable Board President and Harbor District Board Members  
**ISSUED BY:** Gary Dehlinger, Port Manager

---

## OVERVIEW

- At Regular Meeting July 21, 2020, the Board of Commissioners requested additional information on sealcoat material and to correct proposal quantities.
- Port received revised quotes from the two contractors that had higher square foot quantities.
- Jack Akin/Port Engineer recommends applying two coats of asphalt sealer.

## DOCUMENTS

- Procurement Request with Quotes and Material Data Information, 22 pages
- OSMB Drawings, 4 pages
- Curry County / ODOT Sealcoat Specifications, 3 pages
- Draft Sealcoat and Striping Agreement, 20 pages

## COMMISSIONERS ACTION

- **Recommended Motion:**  
Motion to approve draft Sealcoat and Striping Agreement with Strahm's Sealcoating & Striping, Inc. for \$19,326 for the Boat Launch Ramp Parking Lot.

# PORT OF BROOKINGS HARBOR

## Procurement Request

Project Name: Launch Ramp sealcoating Contract No. \_\_\_\_\_

<input type="checkbox"/> Purchase Agreement Purchase Order No. _____	<input type="checkbox"/> Contract
---	-----------------------------------

Award Information:

Company Name: Strahm's sealcoat + stripping INC  
Contact Person: \_\_\_\_\_  
Address: \_\_\_\_\_  
Telephone: \_\_\_\_\_

Special Notes or Comments:  
TWO COATS  
Single coat only

No.	Proposals / Quotes	Units	Quantity	Total \$
	<u>Strahm's</u>	<u>2nd coat</u>		<u>\$ 14,050.00</u>
	<u>Rentro stripping + sealcoat</u>	<u>\$ 25,823</u>		<u>\$ 17,268.00</u>
	<u>Rocky Mtn. Construction</u>			<u>\$ 32,890.00</u>

Prepared by: Travis Webster  
Print Name

Fund Account:  General Fund  Capital Improvements  Debt Service  Revenue Bond  
Department:  Marina  Boat Yard  RV Park  Port Office  Fuel Dock  Commercial Retail

Approved by GM: \_\_\_\_\_  
Signature Print Name Date

Approved by Board Commissioner: \_\_\_\_\_  
Signature Print Name Date

Approved by Board Commissioner: \_\_\_\_\_  
Signature Print Name Date



P.O. Box 7011  
Brookings, Oregon 97415  
OR License #165574/ CA License  
#775623  
541-661-3919

Customer: Port of Brookings		
Address:		
City: Brookings	State: OR	Zip:
Contact Name: Travis	Contact Number: 541-291-7380	
Email Address: travis@portofbrookingsharbor.com		

Project Description	Cost
Prep all asphalt within Port of Brookings parking lot and apply industrial grade asphalt sealer to approximately 87,137 sq ft of asphalt. <b>Single coat only.</b>	\$ 13,070.00
Highly recommended 2 <sup>nd</sup> coat of asphalt sealer, especially with newer asphalt. <b>Optional.</b>	\$ 5276.00
Restripe all ADA spaces, arrows, lettering, and all parking stall lines after sealer has cured.	\$ 980.00
<b>Project Total with recommended 2 coats</b>	<b>\$ 19,326.00</b>

w/out second coat \$ 14,050.00

Gabe Hoenke/Hollie Strahm Prepared by	7.8.20 Date
Accepted by	Date

# ARMOR SEAL PAVEMENT SEALER A-100



## PREPARATION:



Immediately prior to sealing, all asphalt surfaces must be thoroughly cleaned and contain no loose material, dirt, dust, and/or deicing chemical residue, etc. Surfaces that are impacted with hard clay, dust, and silt, that cannot be removed by mechanical sweepers or blowers must be pressure washed. If dirty surfaces are not properly cleaned, the sealer cannot bond or grip to the surface and de-bonding of the coating will occur. Sources of water run off such as landscape irrigation should be shut off, and the asphalt surface must be completely dry prior to application. New asphalt surfaces must cure a minimum of thirty days before application.

Prior to final clean up and seal coat application, all asphalt patching, paving, crack filling, or other repair and construction work must be completed. Potholes, severely cracked areas, and similar surface defects must be repaired as needed with a suitable hot mix asphalt. Treat all grease, oil, gasoline, and similar petroleum build-up or stains with Prep Seal oil spot primer A-500. Cracks in excess of 1/4" wide shall be cleaned and filled with Dura-Fill H.S. (Heat Stabilized) hot applied crack filler A-420 or approved equal.

## MIXING



Concentrated Armor A-100 can be mixed with up to three pounds of #30 to #80 gradation silica sand per gallon. During application, A-100 and silica sand (if added), must be kept agitated and in a constant state of uniform suspension. Sand can be added to one or both coats. Prior to application, concentrated Armor A-100 may be mixed with water from 15 to 20 percent depending upon surface conditions. A-600 (Maxi-Tuff) can then be added to the diluted mix based upon a ratio of 1 to 3 percent per gallon of undiluted A-100. Refer to chart A-1.1.

## APPLICATION:



Concentrated Armor Seal and specified water dilution should be applied in parallel ribbons with a squeegee or approved spray application equipment. One or multiple coat application is acceptable method. Where possible, the first coat of sealer should be allowed to dry for 12 hours prior to the application of a second coat. Multiple coats should be applied in cross directions. It is recommended that Armor Seal A-100 be allowed to cure for 24 hours before opening to traffic. New (less than 60 days old) or heavily oxidized surfaces, should be prime coated with CSS1h, or A-100, diluted 100 percent (1 to 1) with water prior to the application of the first coat of sealer.

## COVERAGE:

Coverage (or yield) will range from 20 to 50 square feet per gallon, depending on surface conditions. Please refer to the following chart for recommended specifications.

Chart A-1.1 A	Traffic Frequency	S/F per gal. of undiluted A-100	Armor A-600 (Maxi-Tuff)
	<b>Light Traffic</b> Residential Driveways; Paved Play Grounds; Bicycle & Golf Cart Paths; Light Use Parking Lots.	40-50 s/f per gallon	<b>Optional:</b> 1%-3% per gal. of undiluted A-100
	<b>Moderate Traffic</b> Residential Streets; Multi-Family Housing; Light to Moderate Use Retail & Commercial Parking.	35-40 s/f per gallon	<b>Optional:</b> 1%-3% per gal. of undiluted A-100.
	<b>Heavy Traffic</b> Industrial and Commercial Facilities; Rail and Port Facilities; Heavily Used Parking Areas; Airport Taxiways & Shipping Terminals.	20-30 s/f per gallon	<b>Optional:</b> 1%-3% per gal. of undiluted A-100.  (same as above)

## CLEAN UP:

Clean up tools and equipment with water. Use diesel fuel if material has hardened.

## CAUTIONS:

Stir and mix thoroughly before using. Do not apply when temperature is below 60° F. Do not apply if rain is expected within 24 hours of application. Keep from freezing. Close containers when not in use. Do not store containerized sealer in direct sunlight or above 100° F. Do not expose containerized sealer to open flame.

## NOTICE:

The methods and techniques described in this application bulletin represent some that have been used successfully to obtain the desired results. All variations in asphalt, climate conditions and equipment cannot be anticipated by Armor Mfg. The decision to use any of these methods and techniques is entirely at the election and responsibility of the user.

## WARRANTY AND DISCLAIMER:

The statements made on this technical bulletin are believed to be true and accurate, and are intended to provide a guide for approved construction practices. Cascade Asphalt Sealing Co. does not make, nor does it authorize any agent or representative to make any warranty, express or implied, concerning this material as workmanship, weather, equipment utilized, and other variables affecting results are all beyond our control. Cascade Asphalt Sealing Co. warrants only that the material conforms to product specifications and any liability to the buyer or use of this product is limited to the replacement value of the product only. In no event shall Cascade Asphalt Sealing Co. be liable for any injury, loss or damage, either direct or incidental, special or consequential, arising in connection with material or work performed. Cascade Asphalt Sealing Co. shall not, in any manner, be liable for any defects, variations, or change in condition in the substructure over which its products are installed.

# A-100 PAVEMENT SEALER PRODUCT DATA BULLETIN



**PRODUCT:** Armor Seal A-100 Concentrated Asphalt Base Pavement Sealer.

A-100 is designed to seal and protect asphalt pavements such as roadways, airports, parking lots and playgrounds. A-100 will add a long lasting, dark black, like new appearance to any asphalt surface and is designed to outlast all other asphalt sealers on the market. If all handling and application instructions are followed, A-100 will extend and preserve asphalt pavement for many years.

**PRODUCT DATA:** A sampling of test results and independent laboratory analysis.

Type (ASTM D-2397 & AASHTO M208).....	CSS1-H Asphalt Emulsion and Selected Fillers
Uniformity (ASTM D-977-91 & 97 & AASHTO M140-88).....	Homogenous
Pounds per gallon(ASTM D-244).....	10.5±
Residue by evaporation (ASTM D 2939).....	54% to 60%
Color when dry.....	Dark Black
Odor.....	Mild
Flammability (ASTM - MNL #9).....	Non-Flammable
Flash Point (ASTM - MNL #9).....	None
Effect of freezing (While In Liquid Storage State).....	Damaging
Storage life.....	One Year
Cone Penetration @ 77° F.(ASTM D-217).....	Passes
Wear/Scrub Resistance (D-2486 - Modified)	
Unconditioned 6,000 cycles minimum.....	Passes
Conditioned 4,000 cycles minimum.....	Passes
Wet track abrasion test (ISSA TB#100 ASTM D 3910.6.4).....	15.9 gm. per sq. ft.

**SOURCES:** AASHTO (American Assoc. of State and Highway Officials).  
ASTM (American Society of Testing Methods).  
ISSA (International Slurry Seal Association).

**PACKAGING:** 5 Gallon Pails, 55 Gallon Drums & Bulk Deliveries

**FOOTNOTES:** The following is a general endorsement from the 'Asphalt Institute' regarding asphalt sealing technology: *"If one does not seal, fine hair line cracks appear in the pavements surface...and this is the start of a maintenance problem... By sealing we then extend the life of the pavements... if one seals immediately, and providing other variables that lead to pavement failure do not come into play, you should be able to extend the pavement life almost indefinitely..."*(Excerpt from letter by Carl W. Lubold, Jr., District Engineer, for the Asphalt Institute.)



**ARMOR SEAL**

# SAFETY DATA SHEET

## Armorseal A-100; Armorseal A-100 HD

### Section 1: IDENTIFICATION

**Product Identifier** : Armorseal A-100; Armorseal A-100 HD  
Asphalt sealcoat; asphalt sealer

**Manufacturer** : Cascade Asphalt Sealing Company  
6238 South Tacoma Way  
Tacoma, Washington 98409-4126

**Recommended Use** : Used to seal and prolong the life of asphalt parking lots

**Telephone Numbers** : Emergency Telephone : Chemtrec 1-800-424-9300  
Product Information : (800) 846-9125

### Section 2: HAZARDS IDENTIFICATION

#### EMERGENCY OVERVIEW

**- MAY CAUSE SKIN AND RESPIRATORY TRACT IRRITATION**

#### GHS Classification of the Substance or Mixture

**Pictogram** : **Signal Word - Warning !**



**Hazard Statements** : H316 Causes mild skin irritation - Category 3  
H303 May be harmful if swallowed  
H320 Causes eye irritation - Category 2B  
H333 May be harmful if inhaled - Category 5  
H335 May cause respiratory irritation - Category 3  
H351 Suspected of causing cancer - Category 2

**Risk Phrases** : R36/37/38 Irritating to eyes, respiratory system, and skin

**Precautionary Statement** : P260 Do not breathe dust/fume/gas/mist/vapors/spray  
P264 Wash hands thoroughly after handling  
P271 Use only in a well ventilated area  
P280 Wear protective gloves/protective clothing/eye protection/face protection

**Safety Phrases** : S24/25 Avoid contact with skin and eyes  
S36 Wear suitable protective clothing  
S37/39 Wear suitable gloves and eye/face protection  
S45 In case of accident or if you feel unwell, seek medical advice immediately



# SAFETY DATA SHEET

## Armorseal A-100; Armorseal A-100 HD

### Health Hazards or Risks From Exposure:

#### ACUTE

- Eye** : Contact may cause mild irritation including stinging, watering and redness.
- Skin** : Contact may cause mild to moderate skin irritation. Prolonged or repeated contact may worsen irritation by causing drying and cracking of the skin leading to dermatitis (inflammation). Long-term skin exposure can increase sensitivity to the sun and cause discoloration. No harmful effects from skin absorption are expected.
- Inhalation** : Vapor or fumes from this material may cause respiratory irritation. Symptoms of respiratory irritation may include coughing and difficulty breathing.
- Ingestion** : Ingestion may cause stomach discomfort.
- Delayed or Other Health Effects** : May cause cancer

### Section 3: COMPOSITION/INFORMATION ON INGREDIENTS

Component	CAS #	Weight %
Asphalt Emulsion Base (Asphalt 100%)	8052-42-4	25-35 %
Slate, Crushed (Crystalline Silica 30-50%)	14808-60-7	25-35 %
Suspension Agent (Clay >95%; Crystalline Silica <3%)	63800-37-3 14808-60-7	2.5-7.5 %
Balance Water	7732-18-5	25-40 %
Proprietary components present at less than 1% each		

### Section 4: FIRST-AID MEASURES

- Eyes** : If irritation or redness develops from exposure to fumes, move victim away from exposure and into fresh air. Remove contact lenses. For contact with the material, hold eyelids apart and flush eyes with plenty of water for at least 15 minutes.
- Skin** : Wear protective gloves to minimize skin contamination. To remove the material from skin, apply a waterless hand cleaner, mineral oil, or petroleum jelly. Then wash with soap and water. As a precaution, remove clothing and shoes if contaminated. Discard contaminated clothing or thoroughly clean before reuse.
- Ingestion** : Do not induce vomiting due to danger of aspirating liquid into lungs. Gastric lavage may be required. Never give anything by mouth to an unconscious person. As a precaution, get medical advice.
- Inhalation** : If respiratory symptoms develop from exposure to fumes, move victim away from source of exposure and into fresh air. If not breathing, give artificial respiration. If breathing is difficult, get medical attention as soon as possible.

### Section 5: FIRE-FIGHTING MEASURES

**Fire Classification** : Not a flammable or combustible liquid

**NFPA Rating System** : Health: 1

Flammability: No Data Available

Reactivity: 0

Effective Date: 9/10/15

b



# SAFETY DATA SHEET

## Armorseal A-100; Armorseal A-100 HD

- Extinguishing Media** : Dry chemical, carbon dioxide, water fog or foam.
- Specific Hazards** : In a fire, hazardous fumes, decomposition products or residues may be produced. Combustion products may include: carbon monoxide, carbon dioxide and oxides of nitrogen and sulfur. Burning of product may release hydrogen sulfide gas.
- Protective Equipment or Precautions** : This material will burn although it is not easily ignited. For fires involving this material, do not enter any enclosed or confined fire space without proper protective equipment, including self-contained breathing apparatus.

### Section 6: ACCIDENTAL RELEASE MEASURES

- Personal Precautions** : Ensure adequate ventilation. Avoid contact with skin, eyes, and clothing. Use personal protective equipment.
- Protective Measures** : Eliminate all sources of ignition in vicinity of spilled material.
- Spill Management** : Stop source of release if you can do it without risk. Contain release to prevent further contamination of soil, surface water or groundwater. Clean up spill as soon as possible.
- Methods for Cleaning Up** : Dam up. Absorb with inert material. Pick up and transfer to properly labeled containers. Clean contaminated surface thoroughly.

### Section 7: HANDLING AND STORAGE

- Handling** : Handle in accordance with good industrial hygiene and safety practices. Do not eat, drink, or smoke while handling this product. Wash thoroughly after handling. Avoid breathing vapors/mists generated by this product. Use in a well-ventilated location.
- Storage** : Do not use or store near heat, sparks or open flame. Store only in a well ventilated area. Keep container closed when not in use. Do not store container in direct sunlight or above 100 F.
- Incompatible Products**: Strong oxidizing agents. Acids.

### Section 8: EXPOSURE CONTROLS/PERSONAL PROTECTION

#### Exposure Limits/Guidelines:

Chemical Name	ACGIH TLV	OSHA PEL
Asphalt 8052-42-4	TWA: 0.5 mg/m3 (Inhalable)	-
Silica, Crystalline 14808-60-7	0.025 mg/m3 (Respirable)	10 + [% quartz + (% cristobalite x 2)+( % tridymite x 2) + 2] (Respirable)
Clay 63800-37-3	10 mg/m3 (Inhalable)	15 mg/m3 (Total) 5 mg/m3 (Respirable)
Cellulose 9004-34-6	TWA: 10 mg/m3 (Total)	TWA: 15 mg/m3 (Total) TWA 5 mg/m3 (Respirable)

**Engineering Controls** : Use in a well ventilated area. Use process enclosures, local exhaust ventilation, or other engineering controls to control airborne levels below the recommended exposure limits.

#### Personal Protective Equipment:

**Eyes/Face** : Where contact with this material is likely, eye protection is recommended. Use safety glasses

Effective Date: 9/10/15

# SAFETY DATA SHEET

## Armorseal A-100; Armorseal A-100 HD

with side shields. Wear ANSI approved eye protection.

- Skin/Body** : Selection of specific items such as gloves, boots, apron or full-body suit will depend on operation.
- Respiratory** : No protective equipment is needed under normal use conditions. If exposure limits are exceeded or irritation is experienced, NIOSH/MSHA approved respiratory protection should be worn.
- Hygiene Measures** : Handle in accordance with good industrial hygiene and safety practices.

### Section 9: PHYSICAL AND CHEMICAL PROPERTIES

Physical State	: Viscous Liquid
Appearance/Color	: Brown to Black
Odor	: Asphaltic
Odor Threshold	: Mild
pH	: No data available
Melting Point/Freezing Point	: No data available
Boiling Point	: No data available
Flash Point	: No data available
Evaporation Rate	: No data available
Flammability	: No data available
Upper/lower Flammability or Explosive Limits	: No data available
Vapor Pressure	: No data available
Vapor Density	: No data available
Specific Gravity	: No data available
Solubility	: No data available
Auto-Ignition Temperature	: No data available
Decomposition Temperature	: No data available
Viscosity	: No data available

### Section 10: STABILITY AND REACTIVITY

Chemical Stability	: Stable under recommended storage and handling conditions.
Hazardous Decomposition Products	: Carbon Monoxide, Carbon Dioxide, Nitrogen Dioxide. Heating may produce Hydrogen Sulfide.
Possibility of Hazardous Reactions	: None under normal processing.
Incompatibility	: Strong oxidizing agents. Acids.
Hazardous Polymerization	: Hazardous polymerization will not occur.
Conditions to Avoid	: Avoid extreme temperatures.

### Section 11: TOXICOLOGICAL INFORMATION

**Toxicity Data** : Toxicity data is not available for mixture

Chemical Name	LD50 Oral (Rat)	LD50 Dermal (Rat)	LC50 Inhalation (Rat)
Asphalt 8052-42-4	5001 mg/kg	2001 mg/kg	-
Silica, Crystalline	ND	ND	ND

Effective Date: 9/10/15

# SAFETY DATA SHEET

## Armorseal A-100; Armorseal A-100 HD

Chemical Name	LD50 Oral (Rat)	LD50 Dermal (Rat)	LC50 Inhalation (Rat)
14808-60-7			
Clay 63800-37-3	ND	ND	ND
Cellulose 9004-34-6	ND	ND	5800 mg/m <sup>3</sup> 4 Hr Rat

**Carcinogenicity** : Suspected Cancer Agent. Product may contain an ingredient(s) that is found on one or more of the following lists:

Chemical Name	ACGIH	IARC	NTP	OSHA
Asphalt	A3	Group 2B	Reasonably Anticipated	X

ACGIH (American Conference of Governmental Industrial Hygienists) A3 - Animal Carcinogen

IRAC (International Agency for Research on Cancer) Group 2B - Possibly Carcinogenic to Humans

NTP (National Toxicity Program) Reasonable Anticipated - Reasonably Anticipated to be a Human Carcinogen

OSHA (Occupational Safety & Health Administration) X-Carcinogen

### Section 12: ECOLOGICAL INFORMATION

**Ecotoxicity** : This material may be toxic to aquatic organisms and should be kept out of sewage and drainage systems and all bodies of water. The environmental impact of this product has not been fully investigated.

**Bioaccumulation** : This product is estimated to have a slow rate of biodegradation. This product is not expected to bioaccumulate through food chains in the environment.

**Other Adverse Effects** : No information available.

### Section 13: DISPOSAL CONSIDERATIONS

**Waste Disposal** : Dispose of waste according to local, state/provincial, and federal requirements. Avoid disposal into wastewater treatment facilities.

**Contaminated Materials** : Treat as product waste.

**Container Disposal** : Do not re-use empty containers.

### Section 14: TRANSPORTATION INFORMATION

**DOT** : Not Regulated as a hazardous material for transport

### Section 15: REGULATORY INFORMATION

**SARA 311/312 Categories** :

Acute Health Hazard	No
Chronic Health Hazard	No
Fire Hazard	No
Sudden Release of Pressure Hazard	No
Reactive Hazard	No

### Section 16: OTHER INFORMATION

This SDS is intended solely for safety education and not for use as specifications or warranties. The information in this SDS was obtained from usually reliable sources and is provided without any representation for warranties regarding the accuracy

# SAFETY DATA SHEET

## Armorseal A-100; Armorseal A-100 HD

or correctness. Since the handling, use, and storage is beyond our control, Cascade Asphalt Sealing Company assumes no responsibility and disclaims liability for any loss, damage, or expense arising therefrom.

### ABBREVIATIONS:

ACGIH	American Conference of Governmental Industrial Hygienists
ANSI	American National Standards Institute
CAS	Chemical Abstract Services (identifies specific chemical)
CO	Carbon Monoxide
DOT	Department of Transportation
EPA	Environmental Protection Agency
GHS	Globally Harmonized System of Classification and Labeling of Chemicals
IARC	International Agency for Research on Cancer
IDLH	Immediately dangerous to life or health
LC50	Lethal concentration - the concentration of a material in air which causes the death of 50% (one half) of a group of test animals
LD50	Lethal dose - the amount of a material, given all at once, which causes the death of 50% (one half) of a group of test animals
mg/m <sup>3</sup>	Milligrams per cubic meter
mg/kg	Milligrams per kilogram
MSHA	Mine Safety Health Act
NA	Not applicable
ND	Not determined
NFPA	National Fire Protection Association
NIOSH	National Institute of Occupational Safety and Health
NTP	National Toxicology Program
OSHA	Occupational Safety and Health Administration
PEL	OSHA Permissible Exposure Limit
ppm	Parts per million
SARA	Superfund Amendments and Reauthorization Act (US EPA)
SDS	Safety Data Sheet
TLV	Threshold Limit Value
TWA	8-hour time-weighted average exposure

Note: Cascade Asphalt Sealing Company periodically updates and revises its product information. To verify this information, please call the number listed in Section 1.

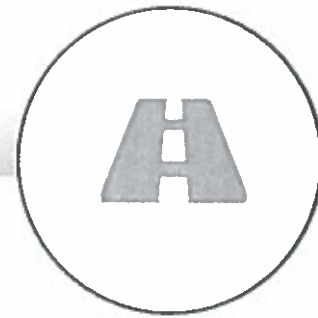
[HOME](#)
[DOCUMENTS](#)
[PRODUCTS](#)
[CATALOG](#)

## OUR PRODUCTS

### ARMORSEAL A-100

Our most popular Sealer, A-100 combines the latest technology, performance and value of any asphalt sealer on the market today.

### ARMORSEAL A-100 HD

A-100 HD is Cascade Asphalt's premier asphalt sealer. A-100 HD is a high performance mineral reinforced asphalt emulsion sealer blended with polymers and special surfactants for superior adhesion, flexibility, and durability

### ARMORSEAL A-400 STA-FLEX

STAR® STA-FLEX™ is a cold pour crack filler based on asphalt emulsion that effectively fills and seals cracks in pavement. STAR® STA-FLEX™ protects

ARMORSEAL A-6 STAR ADVANTAGE 4® based additive that pack several types of product boosting, color enhancir building. STAR ADVANT polymers that reinforce overall performance of s components in the formu drying chemicals, color promoting surfactants th combination of the most product. It is recommend sealcoatings to improve sealcoatings.

• Speeds up the drying t

# RENFRO STRIPING & SEALCOAT

P.O. BOX 1334  
PHOENIX, OR 97535  
(541) 512-1773 / cell (541) 944-0953  
FAX (541) 512-1773  
CCB# 170604

# PROPOSAL

DATE: 7/22/2020

JOB# BOAT RAMP & PARKING LOT  
SEALCOAT AND STRIPING

FOR: PORT OF BROOKINGS HARBOR

BROOKINGS, OR  
541-661-7280

CONTACT: TRAVIS WEBSTER

travis@portofbrookingsharbor.com

SITE LOCATION:  
HARBOR BOAT RAMP & PARKING LOT

Description of work to be performed :

### CLEAN, SEALCOAT & STRIPE :

SLURRY SEALCOAT (A-100 Armorseal)	85,550 sq.ft.	\$0.16 sq.ft.	\$13,688.00
<b>STRIPING</b>			
PARKING STALLS (auto & trailer)	68 ea.	\$10.00 ea.	\$680.00
HANDICAP PARKING STALLS	2 ea.	\$25.00 ea.	\$50.00
4" LINE (hashing & center)	2,700 ln.ft.	\$0.30 ln.ft.	\$810.00
ARROWS	11 ea.	\$20.00 ea.	\$220.00
LARGE TRIANGLES	6 ea.	\$5.00 ea.	\$30.00
12" CROSSWALK	450 ln.ft.	\$0.80 ln.ft.	\$360.00
8" SINGLE CAR PARKING ONLY (text)	15 ea.	\$20.00 ea.	\$300.00
8" BOAT TRAILER PARKING ONLY (text)	54 ea.	\$20.00 ea.	\$1,080.00
12" READY AREA (text)	1 ea.	\$20.00 ea.	\$20.00
12" NUMBERS	6 ea.	\$5.00 ea.	\$30.00

**TOTAL BID AMOUNT: \$17,268.00**

Second Coat @ .10¢ sq ft @ 85,550 sq ft = \$8,555.00

BID APPROVED BY:

PLEASE SIGN FOR ACCEPTANCE OF BID AND SCHEDULING,  
FAX OR EMAIL

Any Questions Contact TIM RENFRO @ (541) 944-0953  
Or At [renfrostriping@yahoo.com](mailto:renfrostriping@yahoo.com)

THANK YOU,

Your Business is Appreciated

\$25,823.00

# ARMOR SEAL PAVEMENT SEALER A-100



**PREPARATION:**



Immediately prior to sealing, all asphalt surfaces must be thoroughly cleaned and contain no loose material, dirt, dust, and/or deicing chemical residue, etc. Surfaces that are impacted with hard clay, dust, and silt, that cannot be removed by mechanical sweepers or blowers must be pressure washed. If dirty surfaces are not properly cleaned, the sealer cannot bond or grip to the surface and de-bonding of the coating will occur. Sources of water run off such as landscape irrigation should be shut off, and the asphalt surface must be completely dry prior to application. New asphalt surfaces must cure a minimum of thirty days before application.

Prior to final clean up and seal coat application, all asphalt patching, paving, crack filling, or other repair and construction work must be completed. Potholes, severely cracked areas, and similar surface defects must be repaired as needed with a suitable hot mix asphalt. Treat all grease, oil, gasoline, and similar petroleum build-up or stains with Prep Seal oil spot primer A-500. Cracks in excess of 1/4" wide shall be cleaned and filled with Dura-Fill H.S. (Heat Stabilized) hot applied crack filler A-420 or approved equal.

**MIXING**



Concentrated Armor A-100 can be mixed with up to three pounds of #30 to #80 gradation silica sand per gallon. During application, A-100 and silica sand (if added), must be kept agitated and in a constant state of uniform suspension. Sand can be added to one or both coats. Prior to application, concentrated Armor A-100 may be mixed with water from 15 to 20 percent depending upon surface conditions. A-600 (Maxi-Tuff) can then be added to the diluted mix based upon a ratio of 1 to 3 percent per gallon of undiluted A-100. Refer to chart A-1.1.

**APPLICATION:**



Concentrated Armor Seal and specified water dilution should be applied in parallel ribbons with a squeegee or approved spray application equipment. One or multiple coat application is acceptable method. Where possible, the first coat of sealer should be allowed to dry for 12 hours prior to the application of a second coat. Multiple coats should be applied in cross directions. It is recommended that Armor Seal A-100 be allowed to cure for 24 hours before opening to traffic. New (less than 60 days old) or heavily oxidized surfaces, should be prime coated with CSS1h, or A-100, diluted 100 percent (1 to 1) with water prior to the application of the first coat of sealer.

**COVERAGE:**

Coverage (or yield) will range from 20 to 50 square feet per gallon, depending on surface conditions. Please refer to the following chart for recommended specifications.

Chart A-1.1 A	Traffic Frequency	S/F per gal. of undiluted A-100	Armor A-600 (Maxi-Tuff)
	<u>Light Traffic</u> Residential Driveways; Paved Play Grounds; Bicycle & Golf Cart Paths; Light Use Parking Lots.	40-50 s/f per gallon	<u>Optional:</u> 1%-3% per gal. of undiluted A-100
	<u>Moderate Traffic</u> Residential Streets; Multi-Family Housing; Light to Moderate Use Retail & Commercial Parking.	35-40 s/f per gallon	<u>Optional:</u> 1%-3% per gal. of undiluted A-100.
	<u>Heavy Traffic</u> Industrial and Commercial Facilities; Rail and Port Facilities; Heavily Used Parking Areas; Airport Taxiways & Shipping Terminals.	20-30 s/f per gallon	<u>Optional:</u> 1%-3% per gal. of undiluted A-100.  (same as above)

**CLEAN UP:**

Clean up tools and equipment with water. Use diesel fuel if material has hardened.

**CAUTIONS:**

Stir and mix thoroughly before using. Do not apply when temperature is below 60° F. Do not apply if rain is expected within 24 hours of application. Keep from freezing. Close containers when not in use. Do not store containerized sealer in direct sunlight or above 100° F. Do not expose containerized sealer to open flame.

**NOTICE:**

The methods and techniques described in this application bulletin represent some that have been used successfully to obtain the desired results. All variations in asphalt, climate conditions and equipment cannot be anticipated by Armor Mfg. The decision to use any of these methods and techniques is entirely at the election and responsibility of the user.

**WARRANTY AND DISCLAIMER:**

The statements made on this technical bulletin are believed to be true and accurate, and are intended to provide a guide for approved construction practices. Cascade Asphalt Sealing Co. does not make, nor does it authorize any agent or representative to make any warranty, express or implied, concerning this material as workmanship, weather, equipment utilized, and other variables affecting results are all beyond our control. Cascade Asphalt Sealing Co. warrants only that the material conforms to product specifications and any liability to the buyer or use of this product is limited to the replacement value of the product only. In no event shall Cascade Asphalt Sealing Co. be liable for any injury, loss or damage, either direct or incidental, special or consequential, arising in connection with material or work performed. Cascade Asphalt Sealing Co. shall not, in any manner, be liable for any defects, variations, or change in condition in the substructure over which its products are installed.



# A-100 PAVEMENT SEALER PRODUCT DATA BULLETIN



**PRODUCT:**           **Armor Seal A-100 Concentrated Asphalt Base Pavement Sealer.**

A-100 is designed to seal and protect asphalt pavements such as roadways, airports, parking lots and playgrounds. A-100 will add a long lasting, dark black, like new appearance to any asphalt surface and is designed to outlast all other asphalt sealers on the market. If all handling and application instructions are followed, A-100 will extend and preserve asphalt pavement for many years.

**PRODUCT DATA:**   **A sampling of test results and independent laboratory analysis.**

Type (ASTM D-2397 & AASHTO M208).....	CSS1-H Asphalt Emulsion and Selected Fillers
Uniformity (ASTM D-977-91 & 97 & AASHTO M140-88).....	Homogenous
Pounds per gallon (ASTM D-244).....	10.5±
Residue by evaporation (ASTM D 2939).....	54% to 60%
Color when dry.....	Dark Black
Odor.....	Mild
Flammability (ASTM - MNL #9).....	Non-Flammable
Flash Point (ASTM - MNL #9).....	None
Effect of freezing (While In Liquid Storage State).....	Damaging
Storage life.....	One Year
Cone Penetration @ 77° F. (ASTM D-217).....	Passes
<b>Wear/Scrub Resistance (D-2486 - Modified)</b>	
Unconditioned 6,000 cycles minimum.....	Passes
Conditioned 4,000 cycles minimum.....	Passes
Wet track abrasion test (ISSA TB#100 ASTM D 3910.6.4).....	15.9 gm. per sq. ft.

**SOURCES:**           **AASHTO** (American Assoc. of State and Highway Officials).  
**ASTM** (American Society of Testing Methods).  
**ISSA** (International Slurry Seal Association).

**PACKAGING:**       5 Gallon Pails, 55 Gallon Drums & Bulk Deliveries

**FOOTNOTES:**       The following is a general endorsement from the 'Asphalt Institute' regarding asphalt sealing technology. *"If one does not seal, fine hair line cracks appear in the pavements surface...and this is the start of a maintenance problem... By sealing we then extend the life of the pavements... if one seals immediately, and providing other variables that lead to pavement failure do not come into play, you should be able to extend the pavement life almost indefinitely..."*(Excerpt from letter by Carl W. Lubold, Jr., District Engineer, for the Asphalt Institute.)

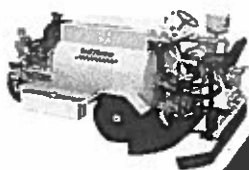

**ARMOR SEAL**



www.rmcpave.com

# Rocky Mountain Construction

4815 Tingley Lane, #A  
Klamath Falls, OR 97603

Phone (541)882-8377

Fax (541)884-3567

Oregon CCB #124715

California CCB #985090

<b>To:</b>	Port Of Brookings Harbor	<b>Contact:</b>	Brent Ferguson
<b>Address:</b>	16330 Lower Harbor Road Brookings, OR 97415	<b>Phone:</b>	541-469-2218
<b>Project Name:</b>	Port Of Brookings Harbor - Sealcoat	<b>Fax:</b>	541-359-3999
<b>Project Location:</b>	Port Of Brookings Marina, Brookings, OR	<b>Bid Number:</b>	
		<b>Bid Date:</b>	7/10/2020

Line #	Item Description	Estimated Quantity	Unit	Total Price
	Sealcoat	1.00	LS	\$32,890.00

**Total Bid Price: \$32,890.00**

### Notes:

- THIS DOCUMENT IS DESIGNATED AS THE PROPOSAL CONTRACT
- ADDITIONAL TERMS AND CONDITIONS LISTED BELOW
- For purposes of this Proposal Contract, "Seller" and "RMC" shall mean Rocky Mountain Construction LLC and "Buyer" shall mean the Owner, acting as the agent of the Owner.
- All contract items subject to "Master Terms and Conditions" labeled as Exhibit A (attached)
- This document and all related exhibits shall constitute the entire contract. Alternately, said documents shall be incorporated into a mutually agreeable subcontract. Submittal of this quotation does not imply agreement to specific subcontract items proposed by the General Contractor or Owner and RMC will not be bound to subcontract language prior to a full negotiation of terms.
- The above prices, specifications, and conditions are satisfactory to the Owner and are hereby accepted. RMC is authorized to perform the work as specified. Payment shall be outlined below. A signed copy of this estimate constitutes a legal contract binding upon the parties listed herein.
- Owner shall purchase and maintain insurance as will protect Owner and RMC from claims with may arise out the the result from Owner's operations under this contract and for which Owner may be legally liable, whether such operations are undertaken by Owner or by anyone directly or indirectly employed by Owner, or by anyone for whose acts any of them may be liable.
- All items subject to a mutually agreed schedule and subject to availability of RMC resources.
- This quotation is submitted as a single package (except as noted above) and may not be modified without RMC's express consent.
- All permits required for the project are to be provided by owner and provided to RMC. RMC will not be responsible for violations of any permits or regulations associated with any permits if they are not provided in writing to RMC and accepted by RMC prior to start of work.
- The following items are excluded unless Seller expressly includes items herein: Excavation; traffic control & flagging; barricades & signs; survey or layout; pavement marking or marking layout; sawcutting; soil sterilization; utility adjustments and/or utility patching; curbing; wheel stops; prime coat; proof rolling; pavement milling; pre-leveling; gravel base; miscellaneous patching (curblines trenches, ramps); sweeping or pavement cleaning; colored, patterned, or stamped asphalt; haul route or street use permits; plans and fees; as-built drawings; Builder's risk insurance; railroad insurance; bonds; participation in any apprenticeship and/or training programs; traffic control plans; cost of Buyer, Owner, or General Contractor required project specific safety training; cost of project specific drug testing.
- All items assume that suitable weather conditions will be present during the time of production or installation. If RMC is required to produce and/or install items in weather conditions that cause RMC to incur additional costs, those additional costs shall be paid to RMC by the Owner.
- Clean and sealcoat approximately 85,550 SF of parking lot.
- Will Need a secure storage area for 2,600 Gallon bulk sealcoat tank.

### Payment Terms:

Payment shall be in full within 10 days of RMC billing. Failure to pay as agreed will result in finance charge of 2% per month for an "Annual Percentage Rate" of 24%. This will be in addition to any collection and/or attorney fees.

### ACCEPTED:

The above prices, specifications and conditions are satisfactory and are hereby accepted.

**Buyer:** \_\_\_\_\_

**Signature:** \_\_\_\_\_

**Date of Acceptance:** \_\_\_\_\_

### CONFIRMED:

**Rocky Mountain Construction LLC**

**Authorized Signature:** \_\_\_\_\_

**Estimator:** Levi Reeves  
(541) 882-8377 lreeves@rmcpave.com

15

# MASTERSEAL ULTRA BLEND PAVEMENT SEALER

**SMT-157**

PORTLAND, OR REVISED 03/23/18

## PRODUCT DESCRIPTION & BENEFITS

MasterSeal Ultra Blend Pavement Sealer is an innovative asphalt sealer for commercial & residential applications.

## COMPONENT TECHNOLOGY

- Spray or squeegee applied
- Rapid curing
- Skid resistance
- Unmatched durability
- No scuffing
- Unequaled deep black color

MasterSeal Ultra Blend is manufactured by SealMaster in Portland, Oregon. When properly applied and cured, the material forms a waterproof, tough, ductile, and skid resistant wearing surface. MasterSeal Ultra Blend prevents surface deterioration by providing resistance to the harmful effects of UV exposure as well as preventing water damage by sealing off the "hair-line" cracks usually associated with early pavement failure.

## SURFACE PREPARATION

All areas to be sealcoated need to be free from sand, dirt, dust, oil build-up, grease and other foreign debris.

## APPLICATION

Application of the seal coat material can be done by either hand squeegee application, equipment capable of squeegee style application or spraying of the sealcoat. Depending on surface texture and traffic load, application can be in one or two separate coats with complete drying of the first coat prior to the application of the second coat.

## CURING

All traffic should be kept off the surface until thoroughly cured and pickup or tracking does not occur. Care should be taken to assure that any sprinkler systems are turned off for at least a 24 hour period during the application process.

## SPECIFICATIONS

- Bulk Density . . . . . 10-11 lbs/gal
- Solids . . . . . 55-60%
- Residue on Base . . . . . 65%
- Pen of Residue. . . . . <25%
- ISSA-WTA . . . . . <5% loss

MASTERSEAL ULTRA BLEND		
PHYSICAL PROPERTY	TEST METHOD	RESULTS
Long Term Weathering >150 months	Controlled Test Field(s)	No cracking, crazing or shrinking fissures. Retains black hue.
Accelerated 10,000 hour QUV	ASTM E 96	Passes. Retains black hue.
Aged color retention. Beckman 5240 spectrophotometer	ASTM E 903	Exhibits less than 3% spectral reflectance at 60 months
Wet track abrasion	ISSA a-105 (TB 100) ASTM 3910	<5 grams loss 6 day soak.
Ductility/Flexibility	ISSA TB 146	Passes @ 32° F
Skid Resistance/Polish Susceptibility	CALTRANS SRL Standard	Passes 35 MPH
Aggregate to asphalt	ISSA TB Boiling test	Passes @ >95% adhesion
Slurry solids content	ASTM D244	58% Maximum
Softening point	AASHTO T-53	60° C Minimum
Penetration @ 77°	AASHTO T-49	25 Maximum
Residue (% by mass)	California T-331	65% Minimum
Phase angle @ 64C (DSR)	AASHTO TP-5	78 Maximum



# SAFETY DATA SHEET

Issuing Date 13-Oct-2016

Revision Date 3-Aug-2018

Revision Number 1

## 1. IDENTIFICATION OF THE SUBSTANCE/PREPARATION AND THE COMPANY/UNDERTAKING

### GHS Product Identifier

Product Name: MasterSeal Ultra

### Other Means of Identification

Product Code(s): S1092  
Synonyms: None

### Recommended Use of the Chemical and Restrictions on Use

Recommended Use: No Information Available  
Uses Advised Against: No information Available

Supplier Address  
SealMaster  
Locations Nationwide  
[www.sealmaster.net](http://www.sealmaster.net)  
1-800-341-7325

Manufacturer Address  
SealMaster  
Locations Nationwide  
[www.sealmaster.net](http://www.sealmaster.net)  
1-800-341-7325

Emergency Telephone Number Chemtrec 1-800-424-9300

## 2. HAZARDS IDENTIFICATION

### Classification

This chemical is not considered hazardous according to the OSHA Hazard Communication Standard 2012 (29 CFR 1910.1200).

### GHS Label Elements, Including Precautionary Statements

#### Emergency Overview

Signal Word	Warning
	
	<ul style="list-style-type: none"> <li>•Harmful if swallowed</li> <li>•May cause skin irritation</li> </ul>
Appearance: Black	Physical State: Liquid
	Odor: Asphaltic

### Precautionary Statements

#### Prevention

Inhalation:

May cause irritation of respiratory tract.

Eye Contact:

Contact with eyes may cause irritation.

Skin Contact:

May cause irritation.

Ingestion:

Ingestion may cause stomach discomfort.

#### General Advice

•None

#### Storage

• Keep container tightly closed

#### Disposal

•Dispose of material/containers in accordance with the appropriate state, regional, or local regulations.

### Hazard Not Otherwise Classified (HNOC)

Not applicable

### 3. COMPOSITION/INFORMATION ON INGREDIENTS

Chemical Name	CAS Number	Weight %	Trade Secret
Limestone	1317-65-3	20-40	*
Asphalt	8052-42-4	20-40	*
Quartz	14808-60-4	<20	*
Kaolin	1332-58-7	<10	*
Bentonite	1302-78-9	<10	*

\*The exact percentage of composition has been withheld as a trade secret.

### 4. FIRST AID MEASURES

#### Description of Necessary First-Aid Measures

**Eye Contact** Rinse thoroughly with plenty of water, also under the eyelids. If symptoms persist, call a physician.

**Skin Contact** Wash off immediately with soap and plenty of water. In the case of skin irritation or allergic reactions, see a physician.

**Inhalation** Move to fresh air. If symptoms persist, call a physician.

**Ingestion** Drink plenty of water. Do NOT induce vomiting. Never give anything by mouth to an unconscious person. Consult a physician if necessary.

#### Most Important Symptoms/Effects, Acute and Delayed

Most Important Symptoms/Effects No information available

#### Indication of Immediate Medical Attention and Special Treatment Needed, If Necessary

Notes to Physician Treat Symptomatically. May cause sensitization by skin contact.

### 5. FIRE-FIGHTING MEASURES

#### Suitable Extinguishing Media

Carbon Dioxide (CO<sub>2</sub>). Dry Chemical. Foam. Water Fog.

Unsuitable Extinguishing Media CAUTION: Use of water spray when fighting fire may be inefficient.

#### Specific Hazards Arising from the Chemical

No information available

#### Explosion Data

Sensitivity to Mechanical Impact None  
Sensitivity to Static Discharge None

#### Protective Equipment and Precautions for Firefighters

As in any fire, wear self-contained breathing apparatus pressure- demand MSHA/NIOSH (approved or equivalent) and full protective gear.

### 6. ACCIDENTAL RELEASE MEASURES

#### Personal Precautions, Protective Equipment, and Emergency Procedures

Personal Precautions: Ensure adequate ventilation. Avoid contact with skin, eyes and clothing. Use personal protective equipment.

#### Environmental Precautions

Environmental Precautions: See Section 12 for additional Ecological Information

#### Methods and Materials for Containment and Cleaning Up

Methods for Containment: Prevent further leakage or spillage if safe to do so.  
Methods for Cleaning Up: Dam up. Soak up with inert absorbent material. Pick up and transfer to properly labeled containers. Clean contaminated surface thoroughly.

### 7. HANDLING AND STORAGE

#### Precautions for Safe Handling

Handling: Handle in accordance with good industrial hygiene and safety practice. Avoid contact with skin, eyes, and clothing. Wear personal protective equipment. Avoid breathing vapors or mists. Do not eat, drink, or smoke when using this product. Wash thoroughly after handling.

**Conditions for Safe Storage, Including Any Incompatibilities**

Storage: Keep container tightly closed  
 Incompatible Products: Strong oxidizing agents. Acids.

**8. EXPOSURE CONTROLS / PERSONAL PROTECTION**

**Control Parameters  
 Exposure Guidelines**

Chemical Name	ACGIH TLV	OSHA PEL	NIOSH IDLH
Limestone 1317-65-3	-	TWA: 15 mg/m <sup>3</sup> TWA: 5 mg/m <sup>3</sup> (vacated) TWA: 15 mg/m <sup>3</sup> (vacated) TWA: 5 mg/m <sup>3</sup>	TWA: 5 mg/m <sup>3</sup> respirable dust TWA 10 mg/m <sup>3</sup> total dust
Asphalt 8052-42-4	TWA: 0.5 mg/m <sup>3</sup> benzene soluble aerosol fume, inhalable fraction	-	Ceiling: 5 mg/m <sup>3</sup> fume 15 min.
Quartz 14808-60-7	TWA: 0.025 mg/m <sup>3</sup> respirable fraction	30/(%SiO <sub>2</sub> +2) mg/m <sup>3</sup> TWA, Total Dust; 250/(%SiO <sub>2</sub> +5) mppcf TWA, respirable fraction; 10/(%SiO <sub>2</sub> +2) mg/m <sup>3</sup> TWA, respirable TWA: 0.1 mg/m <sup>3</sup> (vacated)	IDLH: 50 mg/m <sup>3</sup> respirable dust TWA: 0.05 mg/m <sup>3</sup> respirable dust
Kaolin 1332-58-7	-	TWA: 15 mg/m <sup>3</sup> total dust TWA: 5 mg/m <sup>3</sup> respirable fraction (vacated) TWA: 10 mg/m <sup>3</sup> total dust (vacated) TWA 5 mg/m <sup>3</sup> respirable fraction	TWA: 15 mg/m <sup>3</sup> total dust TWA: 5 mg/m <sup>3</sup> respirable dust
Bentonite 1302-78-9	TWA 1 mg/m <sup>3</sup> respirable fraction	-	-

**Appropriate Engineering Controls**

Engineering Measures: Showers  
 Eyewash Stations  
 Ventilation Systems

**Individual Protection Measures, such as Personal Protective Equipment**

Eye/Face Protection: If splashes are likely to occur, wear: Safety glasses with side shields.  
 Skin and Body Protection: Impervious gloves.  
 Respiratory Protection: No protective equipment is needed under normal use conditions. If exposure limits are exceeded or irritation is experienced, NIOSH/MSHA approved respiratory protection should be worn.

Hygiene Measures: Handle in accordance with good industrial hygiene and safety practice.

**9. PHYSICAL AND CHEMICAL PROPERTIES**

**Information on Basic Physical and Chemical Properties**

Physical State: Liquid  
 Odor: Asphaltic  
 Appearance: Black  
 Odor Threshold: No Information Available

Property	Values	Remarks/Method
pH	No data available	None known
Melting Point/Range	No data available	None known
Boiling Point/Boiling Range	100° C	None known
Flash Point	No data available	None known
Evaporation Rate	No data available	None known
Flammability (solid, gas)	No data available	None known
Flammability Limits in Air		
Upper flammability limit	No data available	
Lower flammability limit	No data available	
Vapor Pressure	No data available	None known
Vapor Density	No data available	None known
Specific Density	1.08-1.32 @ 77 F	None known
Water Solubility	Easily dispersible	None known
Solubility in other solvents	No data available	None known
Partition coefficient: n-octanol/water	No data available	None known
Autoignition Temperature	No data available	None known
Decomposition Temperature	No data available	None known
Viscosity	No data available	None known

Flammable Properties Not Flammable  
 Explosive Properties No data available  
 Oxidizing Properties No data available  
 VOC Content Less than 15 g/l

### 10. STABILITY AND REACTIVITY

Reactivity: No data available  
 Chemical Stability: Stable under recommended storage conditions.  
 Possibility of Hazardous Reactions: None under normal processing.  
 Hazardous Polymerization: Hazardous polymerization does not occur.  
 Conditions to Avoid: None known  
 Incompatible Materials: Strong oxidizing agents. Acids.  
 Hazardous Decomposition Products: Carbon Monoxide (CO), Carbon Dioxide (CO<sub>2</sub>), Hydrogen Sulfide, Nitrogen Dioxide

### 11. TOXICOLOGICAL INFORMATION

#### Information on Likely Routes of Exposure

##### Product Information

Inhalation: May cause irritation of respiratory tract.  
 Eye Contact: Contact with eyes may cause irritation.  
 Skin Contact: May cause irritation.  
 Ingestion: Ingestion may cause stomach discomfort.

Chemical Name	LD50 Oral	LD50 Dermal	LD50 Inhalation
Asphalt	5000 mg/kg (Rat)	>2000 mg/kg (Rabbit)	-
Quartz	500 mg/kg (Rat)		
Bentonite	>5000 mg/kg (Rat)	-	-

#### Symptoms Related to the Physical, Chemical, and Toxicological Characteristics

Symptoms: No information available.

#### Delayed and Immediate Effects and also Chronic Effects from Short and Long Term Exposure

Sensitization: No information available.  
 Mutagenic Effects: No information available.  
 Carcinogenicity: The table below indicates whether each agency has listed any ingredient as a carcinogen. The IARC, NTP, and OSHA do not list asphalt as a carcinogen. In general, the oxidation of polycyclic aromatic hydrocarbons destroys their carcinogenic potential. Petroleum asphalt, shale oil asphalts, and coal tars show distinct variation in their relative carcinogenicity for experimental animals. This product contains crystalline silica (quartz) in a non-respirable form. Inhalation of crystalline silica is unlikely to occur from exposure to this product.

Chemical Name	ACGIH	IARC	NTP	OSHA
Asphalt	A3	Group 2B	Reasonably Anticipated	X
Quartz	A2	Group 1	Known	X

ACGIH: (American Conference of Governmental Industrial Hygienists)

A3 – Animal Carcinogen

A2 – Suspected Human Carcinogen

IRAC: (International Agency for Research on Cancer)

Group 2B – Possibly Carcinogenic to Humans

Group 1 – Carcinogenic to Humans

NTP: (National Toxicity Program)

Reasonably Anticipated – Reasonably Anticipated to be a Human Carcinogen

Known – Known Human Carcinogen

OSHA: (Occupational Safety & Health Administration)

X – Present

Reproductive Toxicity: No information available.  
 STOT - Single Exposure: No information available.  
 STOT – Repeated Exposure: No information available.  
 Aspiration Hazard: No information available.

#### Numerical Measures of Toxicity – Product

The following values are calculated based on Chapter 3.1 of the GHS document

LD50 Oral: 12542 mg/kg, Acute toxicity estimate

LD50 Dermal: 6181 mg/kg, Acute toxicity estimate



**12. ECOLOGICAL INFORMATION**

**Ecotoxicity**

The environmental impact of this product has not been fully investigated.

Chemical Name	Toxicity to Algae	Toxicity to Fish	Toxicity to Microorganisms	Daphnia Magna (Water Flea)
Bentonite 1302-78-9		LC50 96 h: 8.0-19.0 g/L (Salmo gairdneri) LC50 96 h: = 19000 mg/L static (Oncorhynchus mykiss)		

**Persistence and Degradability:** No information available.  
**Bioaccumulation**

Chemical Name	Log Pow
Asphalt	6.006

**Other Adverse Effects:** No information available.

**13. DISPOSAL CONSIDERATIONS**

**Waste Disposal Methods:** This material, as supplied, is not a hazardous waste according to Federal regulations (40 CFR 261). This material could become a hazardous waste if it is mixed with or otherwise comes in contact with a hazardous waste, if chemical additions are made to this material, or if the material is processed or otherwise altered. Consult 40 CFR 261 to determine whether the altered material is a hazardous waste. Consult the appropriate state, regional, or local regulations for additional requirements.

**Contaminated Packaging:** Do not re-use empty containers.

**14. TRANSPORTATION INFORMATION**

**DOT:** Not regulated

**15. REGULATORY INFORMATION**

**International Inventories**  
TSCA – Complies  
DSL/NDSL – Complies

**Legend**  
TSCA – United States Toxic Substances Control Act Section 8(b) Inventory  
DSL/NDSL – Canadian Domestic Substances List/Non-Domestic Substances List

**U.S. Federal Regulations**  
Section 313 of Title III of the Superfund Amendments and Reauthorization Act of 1986 (SARA). This product contains a chemical or chemicals which are subject to the reporting requirements of the Act and Title 40 of the Code of Federal Regulations, Part 372:

Chemical Name	CAS Number	Weight %	SARA 313 – Threshold Values %
Asphalt	8052-42-4	20-40	0.1

**SARA 311/312 Hazard Categories**

Acute Health Hazard	No
Chronic Health Hazard	No
Fire Hazard	No
Sudden Release of Pressure Hazard	No
Reactive Hazard	No

**Clean Water Act**  
This product does not contain any substances regulated as pollutants pursuant to the Clean Water Act (40 CFR 122.21 and 40 CFR 122.42).

**CERCLA**

This material, as supplied, does not contain any substances regulated as hazardous substances under the Comprehensive Environmental Response Compensation and Liability Act (CERCLA) (40 CFR 302) or the Superfund Amendments and Reauthorization Act (SARA) (40 CFR 355). There may be specific requirements at the local, regional, or state level pertaining to releases of this material.

**U.S. State Regulations**

California Proposition 65:

Chemical Name	CAS Number	California Prop. 65
Quartz	14808-60-7	Carcinogen

**U.S. State Right-To-Know Regulations**

"X" designates that the ingredients are listed on the state right to know list.

Chemical Name	New Jersey	Massachusetts	Pennsylvania	Illinois	Rhode Island
Limestone	X	X	X		X
Asphalt	X	X	X		X
Quartz	X	X	X		X
Kaolin	X	X	X		X

**U.S. EPA Label Information**

EPA Pesticide Registration Number: Not applicable

**16. OTHER INFORMATION**

<b>NFPA</b>	Health Hazard: 1	Flammability: 0	Instability: 0	Physical and Chemical Hazards- Personal Protection: X
<b>HMIS</b>	Health Hazard: 1	Flammability: 0	Physical Hazard: 0	

Revision Date: 3-Aug-2018  
Revision Note: No information available.

**General Disclaimer**

The information provided on this SDS is correct to the best of our knowledge, information, and belief at the date of its publication. The information given is designed only as a guide for safe handling, use, processing, storage, transportation, disposal and release and is not to be considered as a warranty or quality specification. The information relates only to the specific material designated and may not be valid for such material used in combination with any other material or in any process, unless specified in the text.



DATE	DESCRIPTION

PROJECT NO. 19-0000  
 SHEET NO. 10000  
 DATE 10/1/00  
 DRAWN BY R. LINDA  
 CHECKED BY [Signature]  
 APPROVED BY [Signature]



**OREGON STATE MARINE BOARD**  
 FOR THE PORT OF BROOKINGS  
 AT THE BROOKINGS MARINA, CHEWOG RIVER MILE 0.4  
**SIDEWALK LAYOUT & ADA RAMP DETAILS**

DATE	DESCRIPTION

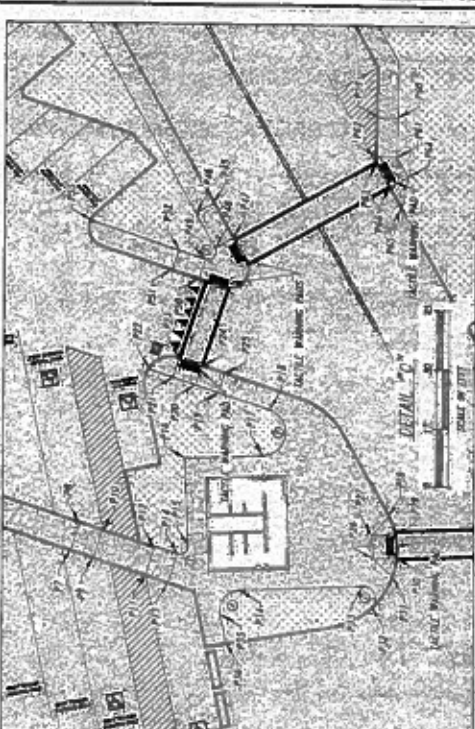
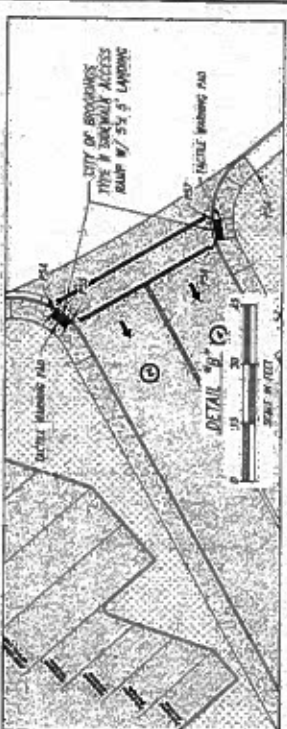
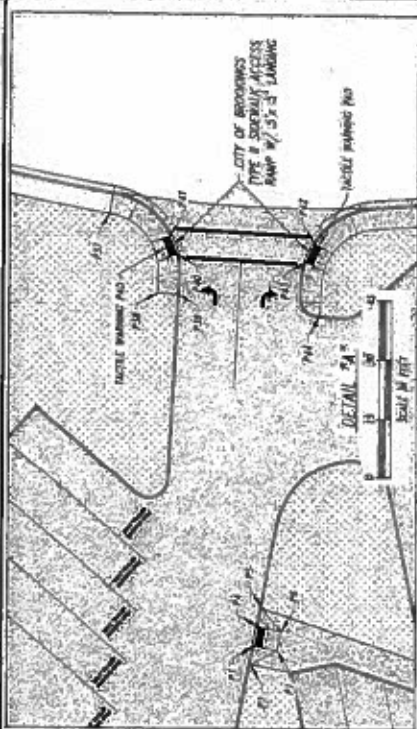

AS ADVERTISED

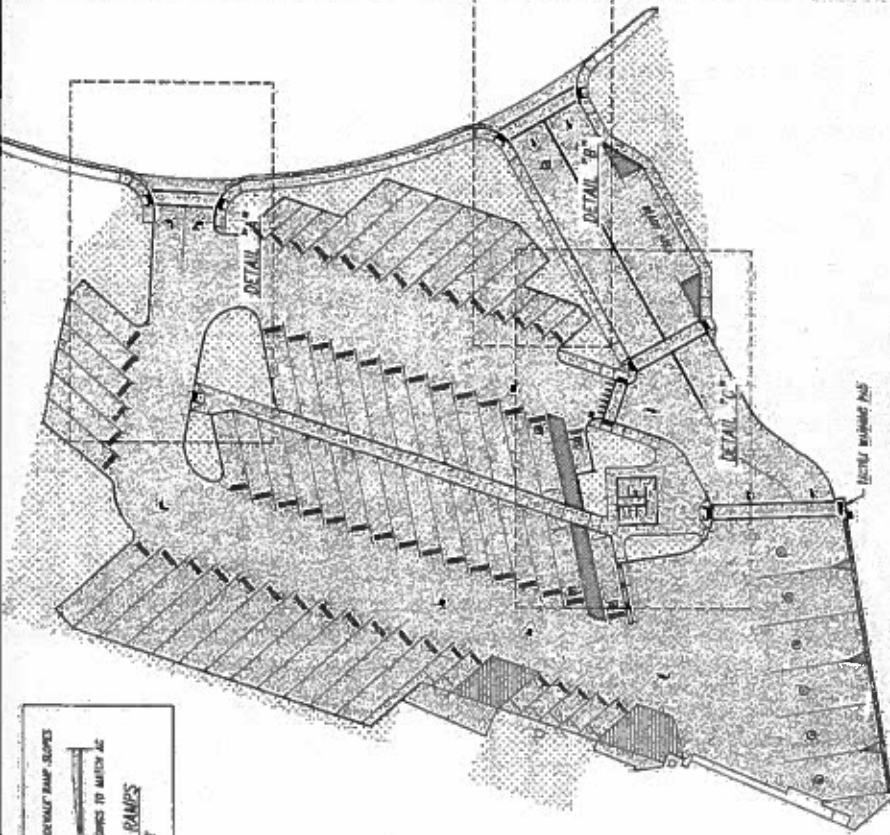

SIDEWALK CURB

1	2	3	4	5	6	7	8	9	10
11	12	13	14	15	16	17	18	19	20

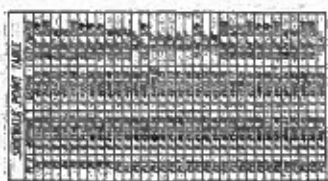
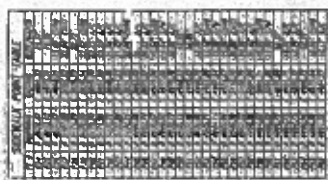

SIDEWALK LAYOUT & ADA RAMP DETAILS

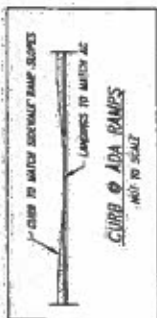

DATE	DESCRIPTION

PROJECT NO. 100000000  
 DRAWING NO. 100000000  
 SHEET NO. 100000000  
 DATE 10/1/00



**OREGON STATE MARINE BOARD**  
 STRIPING & SIGN LAYOUT PLAN  
 AT THE BROOKINGS MARINA, CHEWOG RIVER MILE 0.4  
 FOR THE PORT OF BROOKINGS

DATE	DESCRIPTION

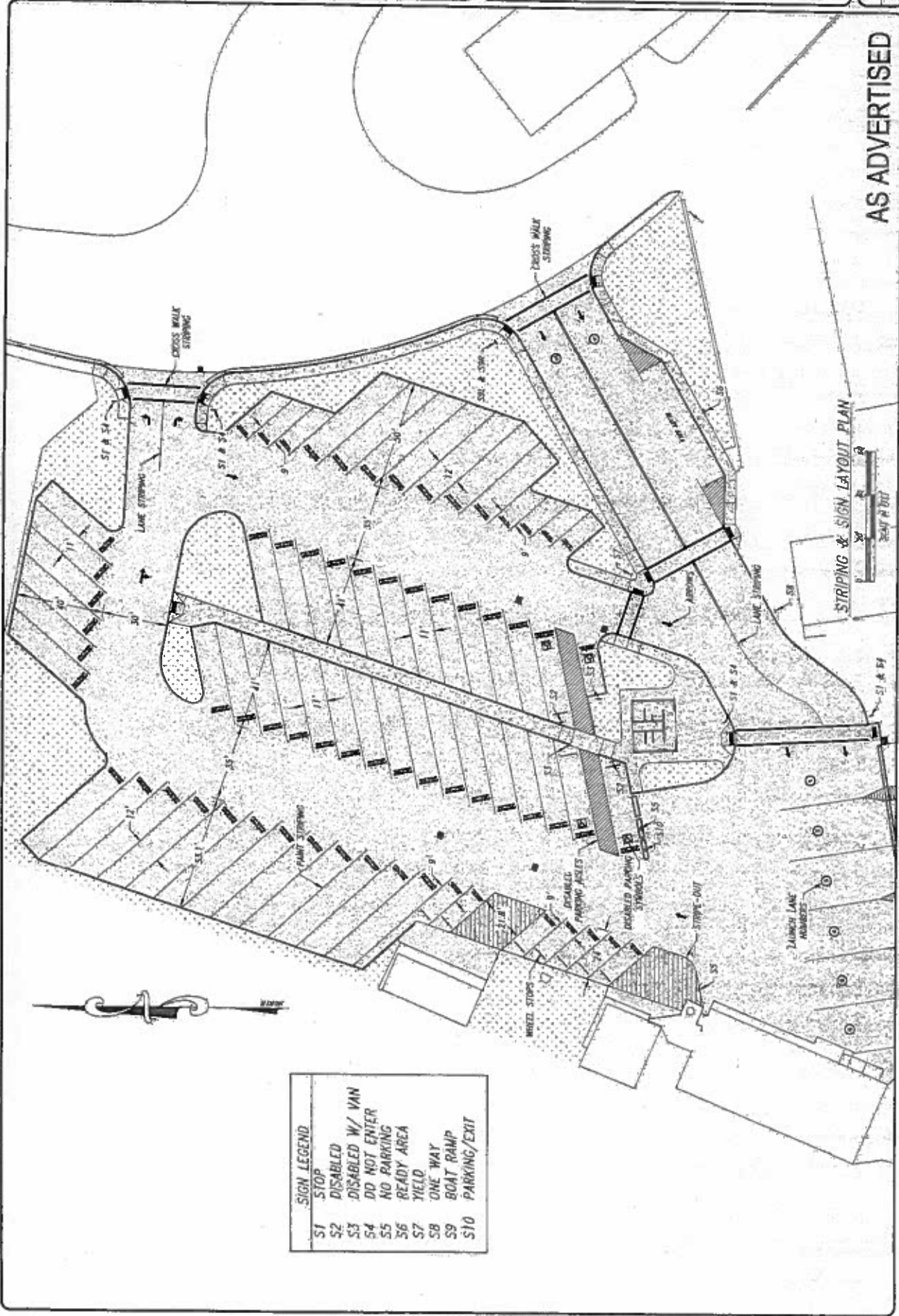

AS ADVERTISED

STRIPING & SIGN LAYOUT PLAN



SIGN LEGEND	
S1	STOP
S2	DISABLED W/ VAN
S3	DISABLED W/ VAN
S4	DO NOT ENTER
S5	NO PARKING
S6	READY AREA
S7	YIELD
S8	ONE WAY
S9	BOAT RAMP
S10	PARKING/EXIT



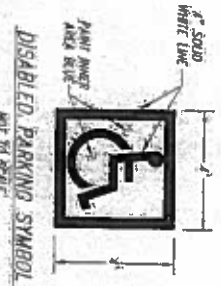
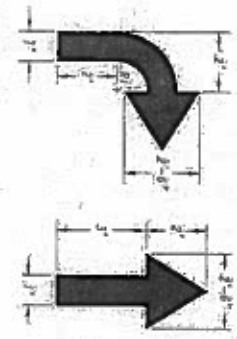
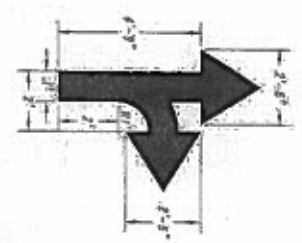
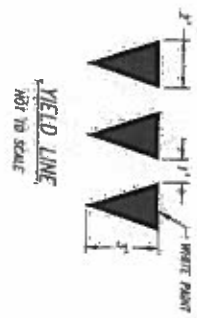
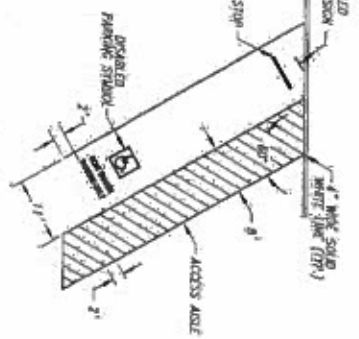
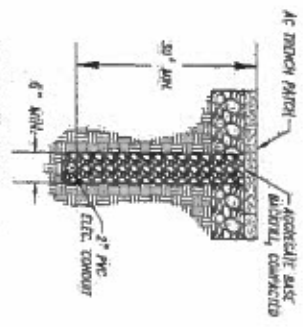
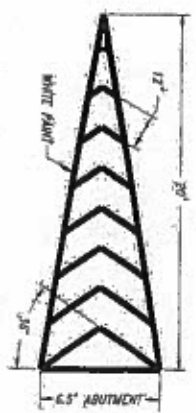
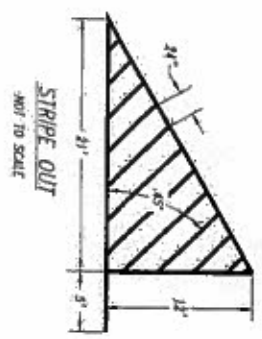
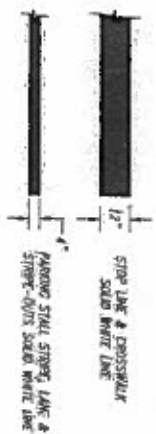

**AS ADVERTISED**

- NOTES:**
1. PAINT ARROWS SHOULD BE PAINTED WITH SOLID WHITE PAINT
  2. EXCEPT WHERE SHOWN OTHERWISE, ALL DIMENSIONS ARE IN FEET AND INCHES
  3. DIMENSIONS OF ARROWS SHOWN ON PARKING

	<b>PAVEMENT MARKINGS &amp; STRIPING DETAILS</b> AT THE BROOKINGS MARINA, CHEYENNE RIVER MILE 0.4 FOR THE PORT OF BROOKINGS			DATE	REVISION	BY
	<b>OREGON STATE MARINE BOARD</b>			DESIGNED BY R. L. LARSEN	CHECKED BY [Signature]	DATE [Blank]

## PART 00700 - WEARING SURFACES

## Section 00705 - Emulsified Asphalt Prime Coat and Emulsified Asphalt Fog Coat

## Description

**00705.00 Scope** - This Work consists of applying asphalt, with or without Aggregate cover materials, to a prepared surface. The prime coat referred to in these Specifications is a penetration treatment to Aggregate surfaces to coat and bind the material into a hard surface. The fog coat referred to in these Specifications is a treatment applied to existing asphalt concrete Pavement surfaces to renew and seal the Pavement surface.

## Materials

**00705.10 Aggregate Cover Material** - When required by the Special Provisions, furnish Aggregate cover material consisting of crushed or uncrushed Rock free of Clay, loam or other harmful substances and meeting the following gradation. Sieve analysis will be determined according to AASHTO T 27. Sieve analysis may be waived and the Aggregate cover material accepted visually if allowed by the Engineer.

Fine Cover		Coarse Cover	
Sieve Size	Percent Passing (by Weight)	Sieve Size	Percent Passing (by Weight)
3/8"	100	1"	100
1/4"	90 - 100	3/4"	90 - 100
No. 8	30 - 66	3/8"	55 - 75
No. 30	8 - 28	1/4"	40 - 60
No. 100	0 - 5	No. 8	*

\* Of the fraction passing the 1/4 inch sieve, 40 to 60 percent shall pass the No. 8 sieve.

**00705.11 Emulsified Asphalt** - Furnish asphalt meeting the following requirements:

(a) **General** - Provide Emulsified Asphalt conforming to the requirement of ODOT's publication, *Standard Specifications for Asphalt Materials*. Copies of the publication are available from the ODOT Pavement Services Engineer. The applicable specifications are those contained in the current publication on the date the Project is advertised. The materials may be conditionally accepted at the source or point of loading for transport to the Project.

Obtain samples of Emulsified Asphalt according to AASHTO T 40, prior to dilution with water, at the frequency in the MFTP. Samples will be tested at the ODOT Materials Laboratory, or other laboratory as designated by the Agency, within 30 Calendar Days from the Day the sample was taken.

(b) **Prime Coat** - Provide CSS-1, CSS-1h, or CMS-2S Emulsified Asphalt for the prime coat.

(c) **Fog Coat** - Provide CSS-1, CSS-1h, or HFRS-P1 Emulsified Asphalt for the fog coat.

For every part Emulsified Asphalt, add not more than one part water. Add water at point of supply or point of application as directed, and mix with Emulsified Asphalt. The exact proportion of added water will be determined in a manner acceptable to the Engineer.



### Equipment

**00705.20 Equipment** - Provide a pressure distributor, hauling vehicles, and other necessary Equipment to ensure efficient operation and construction to meet specified results. Provide Equipment in such number and capacities as will provide coordinated and uniform progress of the Work.

**00705.21 Asphalt Distributor** - Provide an asphalt distributor designed, equipped, maintained, and operated so the Emulsified Asphalt material is applied uniformly at even heat. The distributor shall be capable of applying the asphalt on variable surface widths up to 16 feet, at readily determined and controlled rates from 0.05 to 2.0 gallons per square yard, and with uniform pressure. The variation allowed from any specified rate shall not exceed 0.02 gallons per square yard. Provide distributor Equipment that includes a tachometer, pressure gauges, accurate volume measuring devices and a thermometer for measuring temperature of tank contents. Provide distributors equipped with a positive power unit for the asphalt pump, and full circulation spray bars adjustable both laterally and vertically. Set the bar height for triple lap coverage.

**00705.22 Aggregate Spreaders** - When Aggregate cover material is required, provide a mechanical spreading device that will spread the Aggregate cover material in a manner acceptable to the Engineer.

**00705.23 Power Brooms** - When Aggregate cover material is required, provide pickup or non-pickup type power brooms equipped with a positive means to control vertical pressure.

### Construction

**00705.40 Season and Weather Limitations** - Do not place the prime coat or fog coat when the air temperature is below 60 °F, or when the Engineer determines that weather or surface conditions are detrimental to proper construction.

**00705.41 Preparation of Underlying Surfaces** - Prepare underlying surfaces according to the following:

(a) **Prime Coats** - Bring Aggregate bases and other bases or foundations, when constructed under the Contract, to the completed and finished condition according to the applicable Specifications.

Bring existing bases and foundations, constructed by others, to the applicable condition according to Section 00610, and within 0.04 foot of established grade and Cross Section.

(b) **Fog Coats** - Apply the fog coat to a clean and dry surface. Clean and remove all loose material by sweeping or other approved methods.

**00705.42 Sequence of Operations** - Construct the prime coat or fog coat with a single spread of asphalt followed immediately with a single spread of Aggregate cover material, if required.

**00705.43 Application of Asphalt** - Apply asphalt according to the following:

(a) **Prime Coats** - Apply asphalt at a uniform rate, normally within a range of 0.20 to 0.75 gallons per square yard of surface. The exact rate of application will be determined by the Engineer.

(b) **Fog Coats** - Apply the diluted Emulsified Asphalt within the range of 0.10 to 0.15 gallons per square yard. The exact rate of application will be determined by the Engineer.

Discontinue application of the Emulsified Asphalt fog coat sufficiently early in the Day to permit the termination of traffic control prior to sunset. Apply Emulsified Asphalt to only one designated Traffic Lane at a time.

**00705.44 Spreading Aggregate Cover Material** - When Aggregate cover material is required, spread the Aggregate cover material within the range of 0.004 to 0.013 cubic yards per square yard as directed.

**Maintenance**

**00705.60 Curing, Maintaining and Opening Prime Coats to Traffic** - Cure the prime coat for a minimum of 3 Calendar Days after construction, as directed, before a succeeding Course is placed upon it. If directed, traffic may be allowed to travel over the prime coat at any time after its construction. During the curing period, when in use by traffic and until it is covered by a succeeding Course, maintain the prime coat to the specified shape and condition, as directed.

**00705.61 Power Brooming Fog Coats** - Following the applications of all Aggregate cover material, carefully broom the entire surface unless brooming damages the fog coat, to remove loose Aggregate that could damage vehicles. Use a minimum of two power brooms.

Subsequent brooming the following 2 days may be directed by the Engineer to ensure that the surface is free of loose Aggregate that could cause vehicle damage.

In curbed areas, use a pickup type power broom. On Bridges, sidewalks and other areas off the roadway, remove all extraneous Aggregates to the satisfaction of the Engineer.

**Measurement**

**00705.80 Measurement** - The quantities of Emulsified Asphalt will be measured on the weight basis.

The quantities of Aggregate cover Material will be measured on the weight basis or on the volume basis in the hauling vehicle.

**Payment**

**00705.90 Payment** - The accepted quantities of Work performed under this Section will be paid for at the Contract unit price, per unit of measurement, for the following items:

Pay Item	Unit of Measurement
(a) Emulsified Asphalt in Prime Coat.....	Ton
(b) Emulsified Asphalt in Fog Coat.....	Ton
(c) Aggregate Cover Material .....	Ton or Cubic Yard

Item (b) includes water required to dilute the Emulsified Asphalt, according to 00705.11(c).

Payment will be payment in full for furnishing and placing all Materials, and for furnishing all Equipment, labor, and Incidentals necessary to complete the Work as specified.

No separate or additional payment will be made for materials used during the maintenance period.

**PORT OF BROOKINGS HARBOR  
SEALCOAT AND STRIPING AGREEMENT**

**DRAFT**

**THIS AGREEMENT** is made and entered into this \_\_\_ day of \_\_\_\_\_ 2020, by and between the Port of Brookings Harbor, an Oregon special district, hereinafter referred to as "POBH" and Strahm's Sealcoating & Striping, Inc., hereinafter referred to as "Contractor", duly authorized to perform such services in Oregon.

**WHEREAS**, the POBH requires construction and related services which Contractor is capable of providing, under terms and conditions hereinafter described; and

**WHEREAS**, the POBH solicited contractors with the ability to sealcoat, and stripe the boat launch ramp parking lot. The Port received 3 quotes from qualified contractors. Port selected Contractor being the lowest quote.

**NOW, THEREFORE**, in consideration of the promises and covenants contained herein, the parties agree as follows:

**1.0. Scope of Work.** Contractor will perform the following scope of work under this Agreement, prep asphalt, apply two coats of asphalt sealer, and stripe per attached layout "Exhibit A" attached hereto and incorporated herein by this reference. Contractor will be required to furnish all labor, tools, and equipment for per attached quote "Exhibit B" attached hereto and incorporated herein by this reference.

**2.0. Compensation & Billing.**

**2.01. Compensation.** POBH will pay Contractor Nineteen Thousand Three Hundred Twenty-Six Dollars (\$19,326) to perform the work as described in Exhibits A & B.

**3.0. Effective Date and Duration.** This Agreement will become effective upon its execution, the submission of certificates of insurance to POBH and the issuance of a notice to proceed by the POBH. This Agreement will expire upon conclusion of project unless otherwise terminated or extended.

**4.0. Schedule for Performance.** Contractor shall complete the Scope of Work within 30 days of issuance of the notice to proceed, subjected to change with Port approval.

**5.0. Prevailing Wage.** If the Project cost exceeds \$50,000 and this Agreement is not otherwise exempt, workers must be paid not less than the specified minimum hourly rate of wage in accordance with ORS 279C.838 and ORS 279C.840. The applicable prevailing wage rates may be accessed via the internet at: <https://www.oregon.gov/BOLI/WHD/PWR/Pages/index.aspx>. Hard copies of the prevailing wage rates publication may be obtained by contacting the Oregon Bureau of Labor and Industries via telephone at: (971) 673-0839. If this Project is subject to the Davis-Bacon Act and the state prevailing rate of wage is higher than the federal prevailing rate of wage, the Contractor and every subcontractor on the Project must pay at least the state prevailing rate of wage as determined under ORS 279C.815.

**6.0. Public Works Bond.** The Contractor must have a public works bond filed with the Oregon Construction Contractors Board before starting work on the Project, unless exempt under ORS 279C.836 (4), (7), (8) or (9).

**7.0. Licensing and Certification.** Contractor is required to maintain, at its own expense, all license and certifications required by the State of Oregon to perform services under this Agreement.

**8.0. Status of Contractor as Independent Contractor.** Contractor acknowledges that for all purposes related to this Agreement, Contractor is and will be deemed to be an independent contractor as defined by ORS 670.600 and not an employee of the POBH, is not entitled to benefits of any kind to which an employee of the POBH is entitled and is solely responsible for all payments and taxes required by law. Furthermore, in the event that Contractor is found by a court of law or any administrative agency to be an employee of the POBH for any purpose, the POBH will be entitled to offset compensation due, or to demand repayment of any amounts paid to Contractor under the terms of this Agreement, to the full extent of any benefits or other remuneration Contractor receives (from the POBH or third party) as a result of said finding and to the full extent of any payments that the POBH is required to make (to Contractor or to a third party) as a result of said finding.

**9.0. Compliance with Public Contract Laws.** Contractor will observe all applicable state and local laws pertaining to public contracts. ORS Chapter 279 requires every public contract to contain certain provisions. Pursuant to ORS 279, the following provisions are part of this contract, as applicable, including without limitation the following:

**9.01. Compliance with Tax Laws.** Contractor represents and warrants that Contractor has complied with the tax laws of this state or a political subdivision of this state, including but not limited to ORS 305.620 and ORS chapters 316, 317 and 318. Contractor covenants to continue to comply with the tax laws of this state or a political subdivision of this state during the term of this Agreement. Contractor understands that Contractor's failure to comply with the tax laws of this state or a political subdivision of this state before execution of this Agreement or during the term of this Agreement is a default for which POBH may terminate this Agreement and seek damages and other relief available under the terms of this Agreement or under applicable law.

**9.02. Compliance with Payment Provisions.** Contractor is required to:

- (a) Make payment promptly, as due, to all persons supplying to Contractor labor or material for the performance of the work provided for in this Agreement.
- (b) Pay all contributions or amounts due the Industrial Accident Fund from the Contractor or subcontractor incurred in the performance of this Agreement.
- (c) Not permit any lien or claim to be filed or prosecuted against the state or a county, school district, municipality, municipal corporation or subdivision thereof, on account of any labor or material furnished.
- (d) Pay to the Department of Revenue all sums withheld from employees under ORS 316.167.

**9.03. Compliance with Wage and Hour Laws.** ORS 279C.520 is hereby incorporated by reference as though set forth in full. Contractor agrees to abide by ORS 279C.520, as applicable.

**9.04. Payment for Medical Care / Workers Compensation.** Contractor shall promptly, as due, make payment to any person, co-partnership, association or corporation furnishing medical, surgical and hospital care services or other needed care and attention, incident to sickness or injury, to the employees of the contractor, of all sums that the Contractor agrees to pay for the services and all moneys and sums that the Contractor collected or deducted from the wages of

employees under any law, contract or agreement for the purpose of providing or paying for the services.

**9.05. Environmental Laws.** As provided by ORS 279C.525, all applicable provisions of federal, state or local statutes, ordinances and regulations dealing with the prevention of environmental pollution and the preservation of natural resources that affect the work under this Agreement are by reference incorporated herein to the same force and effect as if set forth herein in full.

**9.06. Other Applicable Laws.** Without limiting the foregoing, Contractor expressly agrees to comply with: (i) Titles VI and VII of the Civil Rights Act of 1964, as amended; (ii) Sections 503 and 504 of the Rehabilitation Act of 1973, as amended; (iii) the Americans with Disabilities Act of 1990, as amended; (iv) Executive Order 11246, as amended; (v) the Health Insurance Portability and Accountability Act of 1996; (vi) the Age Discrimination in Employment Act of 1967, as amended, and the Age Discrimination Act of 1975, as amended; (vii) the Vietnam Era Veterans' Readjustment Assistance Act of 1974, as amended; (viii) ORS Chapter 659, as amended; (ix) all regulations and administrative rules established pursuant to the foregoing laws; and (x) all other applicable requirements of federal and state civil rights and rehabilitation statutes, rules and regulations. A condition or clause required by law to be in this contract shall be considered included by these references.

**10.0. Drug Testing Program.** ORS 279C.505 requires that all public improvement contracts contain a provision requiring contractors to demonstrate that an employee drug-testing program is in place. The Contractor demonstrates that a drug-testing program is in place by signing of this Agreement. The drug testing program will apply to all employees and will be maintained for the duration of the Agreement. Failure to maintain a program constitutes a material breach of contract.

**11.0. Salvage, Composting or Mulching.** If this Agreement is for demolition work, Contractor must salvage or recycle construction and demolition debris, if feasible and cost-effective. If this is a contract for lawn and landscape maintenance, Contractor must compost or mulch yard waste material at an approved site, if feasible and cost-effective.

**12.0. Termination for Convenience.**

**12.01.** This Agreement may be terminated without cause prior to the expiration of the agreed upon term by mutual written consent of the parties and for the following reasons:

- (1) If work under the Contract is suspended by an order of a public agency for any reason considered to be in the public interest other than by a labor dispute or by reason of any third party judicial proceeding relating to the work other than a suit or action filed in regard to a labor dispute; or
- (2) If the circumstances or conditions are such that it is impracticable within a reasonable time to proceed with a substantial portion of the Contract.

**12.02.** Payment of Contractor will be as provided by ORS 279C.660 and will be prorated to and include the day of termination and will be in full satisfaction of all claims by Contractor against POBH under this Agreement.

**12.03.** Termination under any provision of this paragraph will not affect any right, obligation, or liability of Contractor or the POBH which accrued prior to such termination.

**13.0. Cancellation with Cause.**

**13.01.** The POBH may terminate this Agreement effective upon delivery of written notice to Contractor, or at such later date as may be established by the POBH, under any of the following conditions:

- (1) If Contractor disregards applicable laws and regulations pertaining to the performance of the work;
- (2) If POBH funding from federal, state, local, or other sources is not obtained and continued at levels sufficient to allow for the purchase of the indicated quantity of services this Agreement may be modified to accommodate a reduction in funds;
- (3) If Federal or State regulations or guidelines are modified, changed, or interpreted in such a way that the services are no longer allowable or appropriate for purchase under this Agreement;
- (4) If any license or certificate required by law or regulation to be held by Contractor, its subcontractors, agents, and employees to provide the services required by this Agreement is for any reason denied, revoked, or not renewed; or
- (5) If Contractor becomes insolvent, if voluntary or involuntary petition in bankruptcy is filed by or against Contractor, if a receiver or trustee is appointed for Contractor, or if there is an assignment for the benefit of creditors of Contractor.

**13.02.** The POBH, by written notice of default (including breach of contract) to Contractor, may terminate the whole or any part of this Agreement:

- (1) If Contractor fails to provide services called for by this Agreement within the time specified herein or any extension thereof; or
- (2) If Contractor fails to perform any of the other provisions of this Agreement, or so fails to pursue the work as to endanger performance of this Agreement in accordance with its terms, and after receipt of written notice from the POBH, fails to correct such failures within ten (10) days or such other period as the POBH may specify.

**13.04.** The rights and remedies of the POBH provided herein related to defaults (including breach of contract) by Contractor are not exclusive and are in addition to any other rights and remedies provided by law or under this Agreement.

**13.05.** If the POBH terminates this Agreement under paragraph 13.01 or 13.02, Contractor will be entitled to receive as full payment for all services satisfactorily rendered and expenses incurred, an amount which bears the same ratio to the total fees specified in this Agreement as the services satisfactorily rendered by Contractor bear to the total services otherwise required to be performed for such total fee; provided, that there is to be deducted from such amount the amount of damages, if any, sustained by the POBH due to breach of contract by Contractor. Damages for breach of contract will be those allowed by Oregon law, reasonable and necessary attorney fees, and other costs of litigation at trial and upon appeal.

**14.0. Access to Records.** Contractor will grant the POBH access to such books, documents, papers and records of Contractor as are directly pertinent to this Agreement for the purpose of making audit, examination, excerpts, and transcripts.

**15.0. Assignment & Delegation.** This Agreement, and all of the covenants and conditions hereof, will inure to the benefit of and be binding upon the POBH and the Contractor respectively and their legal representatives. Contractor may not assign any rights nor delegate any duties incurred by this contract, or any part hereof without the written consent of the POBH, and any assignment or delegation in violation hereof will be void.

**16.0. Force Majeure.** Neither the POBH nor Contractor will be considered in default because of any delays in completion of responsibilities hereunder due to causes beyond the control and without fault or negligence on the part of the party so disenabled, including, but not restricted to, an act of God or of a public enemy, volcano, earthquake, fire, flood, epidemic, quarantine, restriction, area-wide strike, freight embargo, unusually severe weather or delay of subcontractor or suppliers due to such cause; provided that the party so disenabled must within ten (10) days from the beginning of such delay, notify the other party in writing of the causes of delay and its probable extent. Such notification may not be the basis for a claim for additional compensation. Each party must, however, make all reasonable efforts to remove or eliminate such a cause of delay or default and, upon cessation of the cause, diligently pursue performance of its obligation under this Agreement.

**17.0. Nonwaiver.** The failure of the POBH to insist upon or enforce strict performance by Contractor of any of the terms of this Agreement or to exercise any rights hereunder may not be construed as a waiver or relinquishment to any extent of its right to assert or rely upon such terms or rights on any future occasion.

**18.0. Warranties.** All work must be guaranteed by the Contractor for a period of one year after the date of final acceptance of the work by the POBH, except that manufacturers' warranties and extended manufacturer warranties shall not be abridged. Contractor warrants that all practices and procedures, workmanship, and materials will be the best available unless otherwise specified in the profession. Neither acceptance of the work nor payment therefore will act to relieve Contractor from liability under warranties contained in or implied by this Agreement. Contractor also warrants that all its work will be performed in accordance with generally accepted professional practices and standards as well as the requirements of applicable federal, state and local laws, it being understood that acceptance of a contractor's work by the POBH will not operate as a waiver or release.

**19.0. Attorney's Fees.** In case suit or action is instituted to enforce the provisions of this Agreement, the parties agree that the prevailing party will be entitled to an award of reasonable attorney's fees and court costs including attorney's fees and court costs on appeal.

**20.0. Governing Law.** The provisions of this Agreement will be construed in accordance with the provisions of the laws of the State of Oregon. Any action or suits involving any questions arising under this Agreement must be brought in the Circuit Court of Curry County or the U. S. District Court in Medford.

**21.0. Indemnification.** Contractor agrees to indemnify, defend and hold harmless the POBH and its officers, agents and employees against all liability, loss and costs arising from actions, suits, claims or demands (including reasonable attorney's fees and costs of suit) attributable in whole or in part to the acts or omissions of Contractor, and Contractor's officers, agents and employees, in performance of this contract.



**22.0. Insurance.** Contractor and its subcontractors must maintain insurance acceptable to the POBH in full force and effect throughout the term of this Agreement. Such insurance must cover all risks arising directly or indirectly out of Contractor's activities or work hereunder, including the operations of its subcontractors of any tier. Such insurance must include provisions that such insurance is primary insurance with respect to the interests of the POBH and that any other insurance maintained by the POBH is excess and not contributory insurance with the insurance required hereunder. The policy or policies of insurance maintained by the Contractor and its subcontractors must provide at least the following limits and coverages:

- (a) Coverages: Contractor and its subcontractors must, at Contractor's expense, maintain during the term of this Agreement, the following insurance policy types with the following minimum coverage limits:

Commercial General Liability Insurance	\$1,000,000.00 Each Occurrence Limit \$2,000,000.00 General Aggregate
Workers Compensation	Per Oregon Law (ORS 656.017)
Employer's Liability	\$500,000 per accident
Comprehensive Automobile Liability Insurance	\$ 1,000,000.00 Each Occurrence CSL \$ 2,000,000.00 Aggregate BI/PD (including coverage for all owned, hired and non-owned vehicles)

- (b) Certificates of Insurance: As evidence of the insurance coverage required by the contract, Contractor must furnish a Certificate of Insurance to the POBH prior to the commencement of work. The certificate must specify and document all of the required insurance provisions within this Agreement.
- (c) Primary Coverage Clarification: All parties to this Agreement hereby agree that Contractor's coverage will be primary in the event of a loss.
- (d) Effect of Insurance: The procuring of such required insurance may not be construed to limit Contractor's liability hereunder. Notwithstanding said insurance, Contractor will be obligated for the total amount of any damage, injury, or loss caused by negligence or neglect connected with this Agreement.

**24.0. Method and Place of Giving Notice, Submitting Bills and Making Payments.** All notices, bills and payments must be made in writing and may be given by personal delivery or by mail. Notices, bills and payments sent by mail should be addressed as follows:

<b>If to Port of Brookings Harbor:</b>	<b>If to Contractor:</b>
Port of Brookings Harbor	Strahm's Sealcoating & Striping, Inc.
Attn: Port Manager	P.O. Box 7011
PO Box 848	Brookings, OR 97415
16330 Lower Harbor Rd	Attn: Gabe Hoenke / Hollie Strahm
Brookings, OR 97415	

and when so addressed, will be deemed given upon deposit in the United States mail, postage prepaid. In all other instances, notices, bills and payments will be deemed given at the time of actual delivery. Changes may be made in the names and addresses of the person to whom notices, bills and payments are to be given by giving written notice pursuant to this paragraph.

**25.0. Hazardous Waste.** If, as a result of performance of this Agreement, Contractor generates any hazardous wastes, Contractor will be responsible for disposal of any such hazardous wastes in compliance with all applicable federal and state requirements. Contractor must provide the POBH with documentation, including all required manifests, demonstrating proper transportation and disposal of any such hazardous wastes. Contractor agrees to defend, indemnify, and hold harmless the POBH for any disposal or storage of hazardous wastes generated pursuant to this Agreement and any releases or discharges of hazardous materials.

**26.0. Severability.** In the event any provision or portion of this Agreement is held to be unenforceable or invalid by any court of competent jurisdiction, the remainder of this Agreement will remain in full force and effect and will in no way be affected or invalidated thereby.

**27.0. Complete Agreement.** This Agreement and the attached exhibits constitute the entire agreement between the parties. There are no understandings, agreements, or representations, oral or written, not specified herein regarding this Agreement.

**28.0. Waiver and Amendment.** No waiver, consent, modification, or change of terms of this Agreement may bind either party unless in writing and signed by both parties. Such waiver, consent, modification, or change if made, will be effective only in specific instances and for the specific purpose given.

**29.0. Acknowledgment.** Contractor, by the signature of its authorized representative, hereby acknowledges that he has read this Agreement, understands it and agrees to be bound by its terms and conditions.

**IN WITNESS WHEREOF,** the parties have executed this Agreement on the date herein above first written.

**PORT OF BROOKINGS HARBOR  
BOARD OF COMMISSIONERS**

**CONTRACTOR: Strahm's Sealcoating & Striping,  
Inc.**

\_\_\_\_\_  
By: Roy C Davis, President

By: \_\_\_\_\_

Name:

ATTEST:

Its:

\_\_\_\_\_  
Port Commissioner

EXHIBIT A

DATE: _____ DRAWN BY: _____ CHECKED BY: _____ APPROVED BY: _____	R. LAMMAY 1/20/14			<b>OREGON STATE MARINE BOARD</b> PROPOSED SITE PLAN AT THE BROOKINGS MARINA, CHETCO RIVER MILE 0.4 FOR THE PORT OF BROOKINGS	SHEET: 10 OF: 10 DRAWING NO.: 0800 - 141 - 3
---	----------------------	--	--	---	--

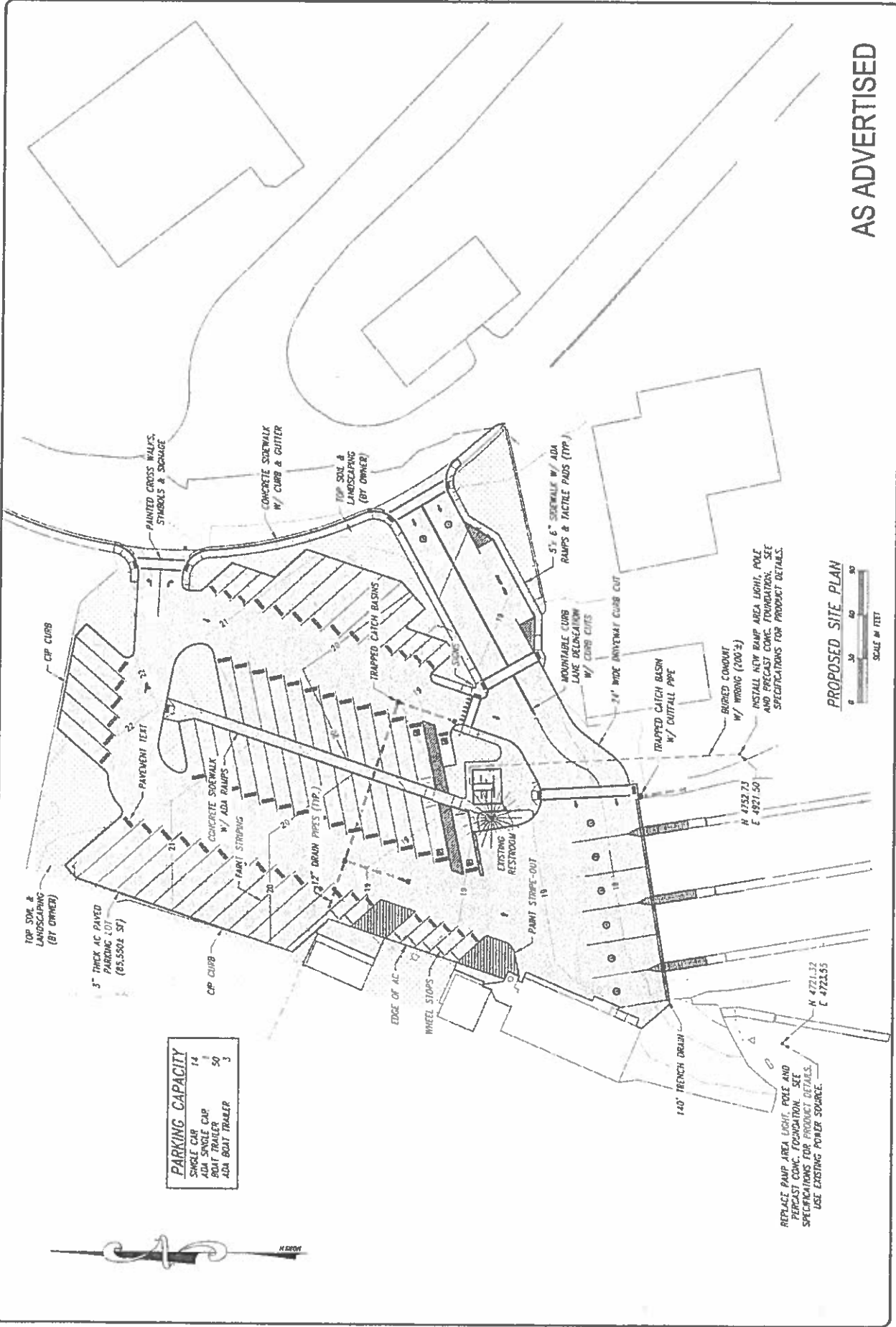

PARKING CAPACITY	
SINGLE CAR	14
ADA SINGLE CAR	1
ADA TRAILER	50
ADA BOAT TRAILER	3



REPLACE PUMP AREA LIGHT, POLE AND PERCAST CONC. FOUNDATION. SEE SPECIFICATIONS FOR PRODUCT DETAILS. USE EXISTING POWER SOURCE.

INSTALL NEW RAMP AREA LIGHT, POLE AND PERCAST CONC. FOUNDATION. SEE SPECIFICATIONS FOR PRODUCT DETAILS.

AS ADVERTISED

DATE	REVISION

DESIGNED BY  
R. LANHAM

CHECKED BY  
R. LANHAM

DATE  
10/05/14



OREGON STATE MARINE BOARD

FOR THE PORT OF BROOKINGS  
AT THE BROOKINGS MARINA, CHETCO RIVER MILE 0.4

PROJECT NO.  
11

DATE  
10/05/14

SCALE  
AS SHOWN

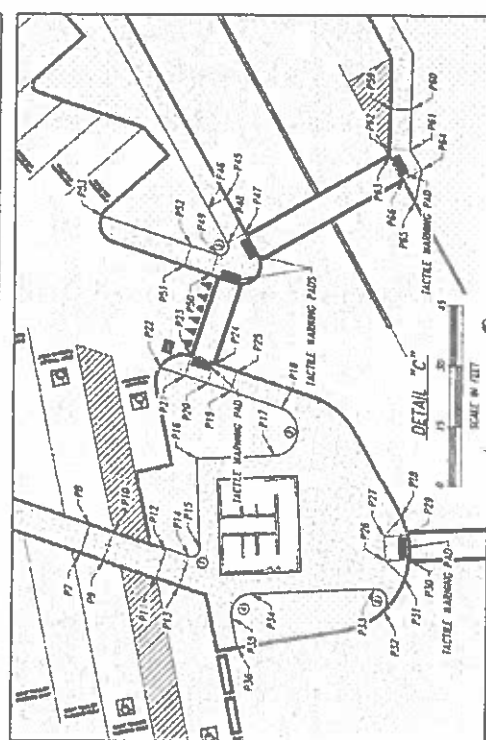
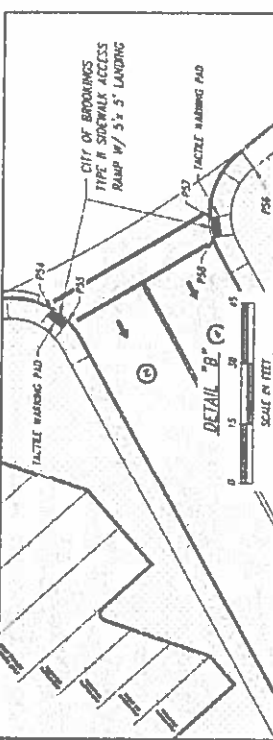
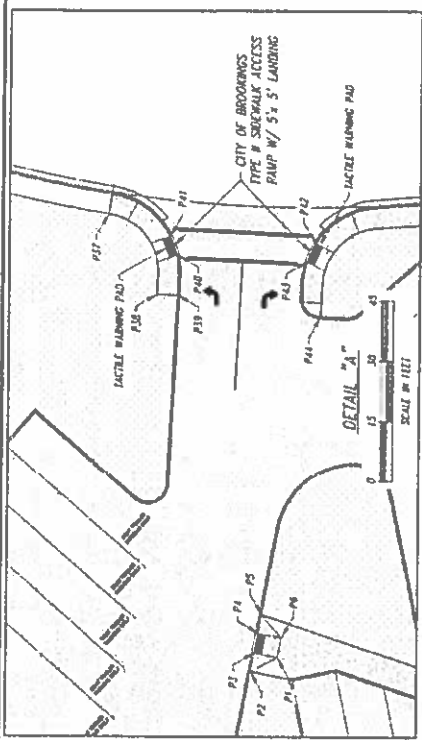

AS ADVERTISED

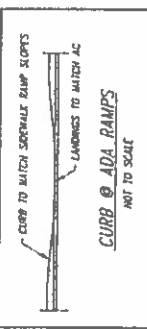
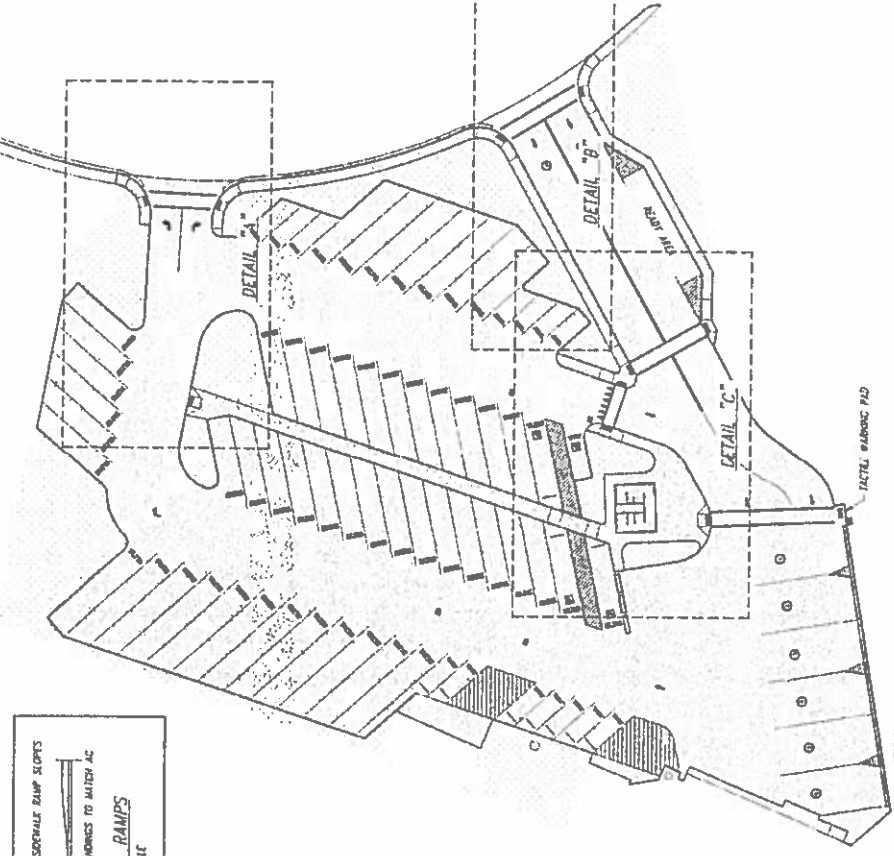

SIDEWALK CURVE TABLE

STATION	CHORD BEARING	CHORD DISTANCE	CHORD CURVE DISTANCE	CHORD CURVE BEARING
1+00.00	112.50°	100.00	100.00	112.50°
1+10.00	112.50°	100.00	100.00	112.50°
1+20.00	112.50°	100.00	100.00	112.50°

SIDEWALK POINT TABLE

STATION	CHORD BEARING	CHORD DISTANCE	CHORD CURVE DISTANCE	CHORD CURVE BEARING
1+00.00	112.50°	100.00	100.00	112.50°
1+10.00	112.50°	100.00	100.00	112.50°
1+20.00	112.50°	100.00	100.00	112.50°

SIDEWALK POINT TABLE

STATION	CHORD BEARING	CHORD DISTANCE	CHORD CURVE DISTANCE	CHORD CURVE BEARING
1+00.00	112.50°	100.00	100.00	112.50°
1+10.00	112.50°	100.00	100.00	112.50°
1+20.00	112.50°	100.00	100.00	112.50°

SIDEWALK LAYOUT & ADA RAMP DETAILS

DATE	10/08/14
DESIGNED BY	R. LAMHAM
CHECKED BY	R. LAMHAM
PROJECT NO.	1000014
SCALE	AS SHOWN
DATE	
BY	



**OREGON STATE MARINE BOARD**  
 STRIPING & SIGN LAYOUT PLAN  
 FOR THE BROOKINGS MARINA, CHETCO RIVER MILE 0.4  
 AT THE BROOKINGS MARINA, CHETCO RIVER MILE 0.4

DATE	10/08/14
BY	
SCALE	AS SHOWN

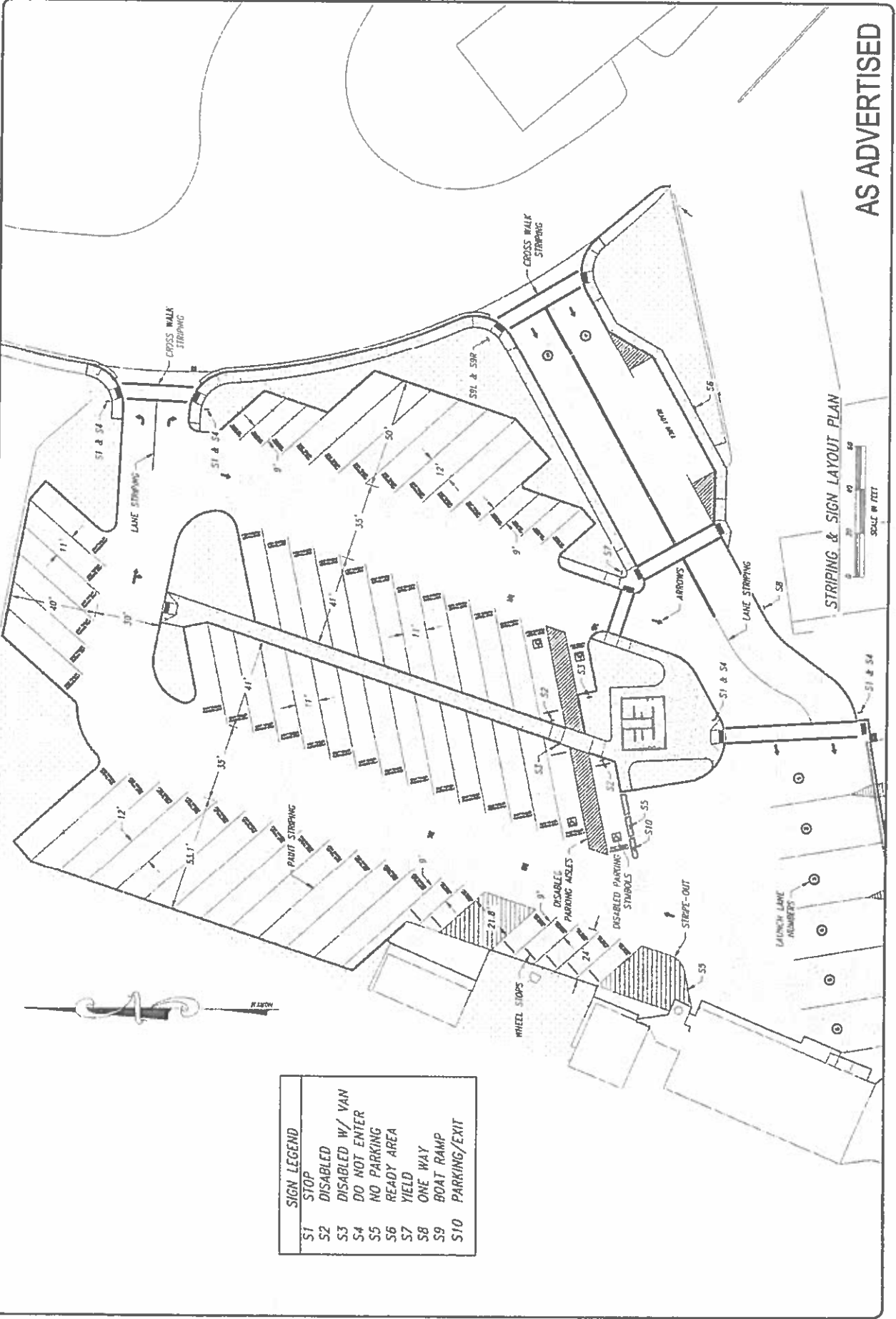

AS ADVERTISED

SIGN LEGEND	
S1	STOP
S2	DISABLED
S3	DISABLED W/ VAN
S4	DO NOT ENTER
S5	NO PARKING
S6	READY AREA
S7	YIELD
S8	ONE WAY
S9	BOAT RAMP
S10	PARKING/EXIT

DATE	REVISION

APPROVED FOR THE BOARD	DATE



OREGON STATE MARINE BOARD

PAVEMENT MARKINGS & STRIPING DETAILS  
AT THE BROOKINGS MARINA, CHETCO RIVER MILE 0.4  
FOR THE PORT OF BROOKINGS

DATE	NO.

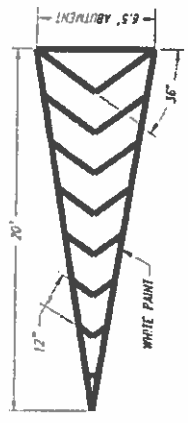

ABUTMENT STRIPEOUT AREA  
NOT TO SCALE

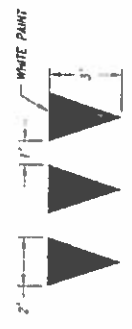

YIELD LINE  
NOT TO SCALE



LANE NUMBERING  
NOT TO SCALE

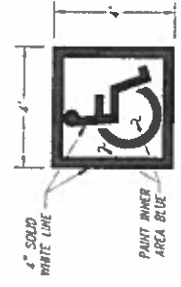

DISABLED PARKING SYMBOL  
NOT TO SCALE

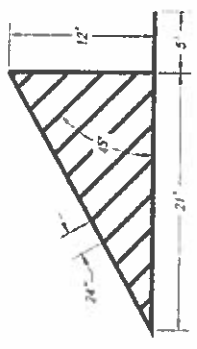

STRIPE OUT  
NOT TO SCALE

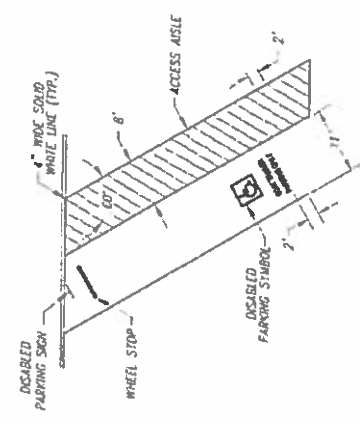

BOAT TRAILER DISABLED STALL  
NOT TO SCALE

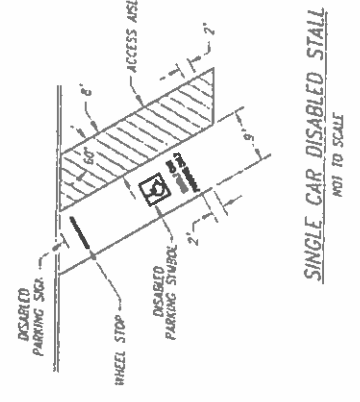

SINGLE CAR DISABLED STALL  
NOT TO SCALE



READY AREA  
SINGLE CAR PARKING ONLY

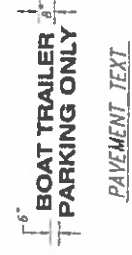

BOAT TRAILER PARKING ONLY  
PAVEMENT TEXT  
NOT TO SCALE

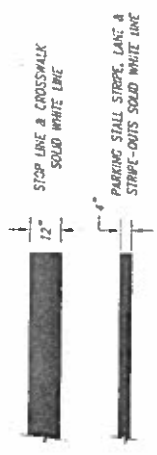

PAVEMENT STRIPING  
NOT TO SCALE

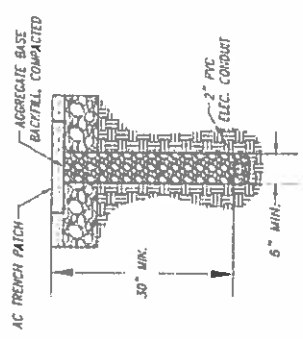

AREA LIGHT TRENCH DETAIL  
NOT TO SCALE

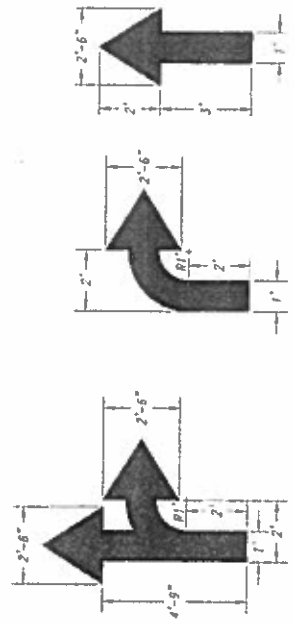

DIRECTIONAL ARROWS  
NOT TO SCALE

- NOTES:
1. PAINT ARROWS SOLID WHITE.
  2. CENTER ARROWS WITHIN TRAFFIC LANE.
  3. LOCATION OF ARROWS SHOWN ON PLANS.

AS ADVERTISED

EXHIBIT B



P.O. Box 7011  
 Brookings, Oregon 97415  
 OR License #165574/ CA License  
 #775623  
 541-661-3919

Customer: Port of Brookings		
Address:		
City: Brookings	State: OR	Zip:
Contact Name: Travis	Contact Number: 541-291-7380	
Email Address: travis@portofbrookingsharbor.com		

Project Description	Cost
Prep all asphalt within Port of Brookings parking lot and apply industrial grade asphalt sealer to approximately 87,137 sq ft of asphalt. <b>Single coat only.</b>	\$ 13,070.00
Highly recommended 2 <sup>nd</sup> coat of asphalt sealer, especially with newer asphalt. <b>Optional.</b>	\$ 5276.00
Restripe all ADA spaces, arrows, lettering, and all parking stall lines after sealer has cured.	\$ 980.00
Project Total with recommended 2 coats	\$ 19,326.00

w/out second coat \$ 14,050.00

Gabe Hoenke/Hollie Strahm  
 Prepared by \_\_\_\_\_ Date 7.8.20

Accepted by \_\_\_\_\_ Date \_\_\_\_\_



# ARMOR SEAL PAVEMENT SEALER A-100



## PREPARATION:



Immediately prior to sealing, all asphalt surfaces must be thoroughly cleaned and contain no loose material, dirt, dust, and/or deicing chemical residue, etc. Surfaces that are impacted with hard clay, dust, and silt, that cannot be removed by mechanical sweepers or blowers must be pressure washed. If dirty surfaces are not properly cleaned, the sealer cannot bond or grip to the surface and de-bonding of the coating will occur. Sources of water run off such as landscape irrigation should be shut off, and the asphalt surface must be completely dry prior to application. New asphalt surfaces must cure a minimum of thirty days before application.

Prior to final clean up and seal coat application, all asphalt patching, paving, crack filling, or other repair and construction work must be completed. Potholes, severely cracked areas, and similar surface defects must be repaired as needed with a suitable hot mix asphalt. Treat all grease, oil, gasoline, and similar petroleum build-up or stains with Prep Seal oil spot primer A-500. Cracks in excess of 1/4" wide shall be cleaned and filled with Dura-Fill H.S. (Heat Stabilized) hot applied crack filler A-420 or approved equal.

## MIXING



Concentrated Armor A-100 can be mixed with up to three pounds of #30 to #80 gradation silica sand per gallon. During application, A-100 and silica sand (if added), must be kept agitated and in a constant state of uniform suspension. Sand can be added to one or both coats. Prior to application, concentrated Armor A-100 may be mixed with water from 15 to 20 percent depending upon surface conditions. A-600 (Maxi-Tuff) can then be added to the diluted mix based upon a ratio of 1 to 3 percent per gallon of undiluted A-100. Refer to chart A-1.1.



## APPLICATION:



Concentrated Armor Seal and specified water dilution should be applied in parallel ribbons with a squeegee or approved spray application equipment. One or multiple coat application is acceptable method. Where possible, the first coat of sealer should be allowed to dry for 12 hours prior to the application of a second coat. Multiple coats should be applied in cross directions. It is recommended that Armor Seal A-100 be allowed to cure for 24 hours before opening to traffic. New (less than 60 days old) or heavily oxidized surfaces, should be prime coated with CSS1h, or A-100, diluted 100 percent (1 to 1) with water prior to the application of the first coat of sealer.

## COVERAGE:

Coverage (or yield) will range from 20 to 50 square feet per gallon, depending on surface conditions. Please refer to the following chart for recommended specifications.

Chart A-1.1 A	Traffic Frequency	S/F per gal. of undiluted A-100	Armor A-600 (Maxi-Tuff)
	<b>Light Traffic</b> Residential Driveways; Paved Play Grounds; Bicycle & Golf Cart Paths; Light Use Parking Lots.	40-50 s/f per gallon	<b>Optional:</b> 1%-3% per gal. of undiluted A-100
	<b>Moderate Traffic</b> Residential Streets; Multi-Family Housing; Light to Moderate Use Retail & Commercial Parking.	35-40 s/f per gallon	<b>Optional:</b> 1%-3% per gal. of undiluted A-100.
	<b>Heavy Traffic</b> Industrial and Commercial Facilities; Rail and Port Facilities; Heavily Used Parking Areas; Airport Taxiways & Shipping Terminals.	20-30 s/f per gallon	<b>Optional:</b> 1%-3% per gal. of undiluted A-100.  (same as above)

**CLEAN UP:** Clean up tools and equipment with water. Use diesel fuel if material has hardened.

**CAUTIONS:** Stir and mix thoroughly before using. Do not apply when temperature is below 60° F. Do not apply if rain is expected within 24 hours of application. Keep from freezing. Close containers when not in use. Do not store containerized sealer in direct sunlight or above 100° F. Do not expose containerized sealer to open flame.

**NOTICE:** The methods and techniques described in this application bulletin represent some that have been used successfully to obtain the desired results. All variations in asphalt, climate conditions and equipment cannot be anticipated by Armor Mfg. The decision to use any of these methods and techniques is entirely at the election and responsibility of the user.

**WARRANTY AND DISCLAIMER:** The statements made on this technical bulletin are believed to be true and accurate, and are intended to provide a guide for approved construction practices. Cascade Asphalt Sealing Co. does not make, nor does it authorize any agent or representative to make any warranty, express or implied, concerning this material as workmanship, weather, equipment utilized, and other variables affecting results are all beyond our control. Cascade Asphalt Sealing Co. warrants only that the material conforms to product specifications and any liability to the buyer or use of this product is limited to the replacement value of the product only. In no event shall Cascade Asphalt Sealing Co. be liable for any injury, loss or damage, either direct or incidental, special or consequential, arising in connection with material or work performed. Cascade Asphalt Sealing Co. shall not, in any manner, be liable for any defects, variations, or change in condition in the substructure over which its products are installed.

# A-100 PAVEMENT SEALER PRODUCT DATA BULLETIN



**PRODUCT:** Armor Seal A-100 Concentrated Asphalt Base Pavement Sealer.

A-100 is designed to seal and protect asphalt pavements such as roadways, airports, parking lots and playgrounds. A-100 will add a long lasting, dark black, like new appearance to any asphalt surface and is designed to outlast all other asphalt sealers on the market. If all handling and application instructions are followed, A-100 will extend and preserve asphalt pavement for many years.

**PRODUCT DATA:** A sampling of test results and independent laboratory analysis.

Type (ASTM D-2397 & AASHTO M208).....	CSS1-H Asphalt Emulsion and Selected Fillers
Uniformity (ASTM D-977-91 & 97 & AASHTO M140-88).....	Homogenous
Pounds per gallon(ASTM D-244).....	10.5±
Residue by evaporation (ASTM D 2939).....	54% to 60%
Color when dry.....	Dark Black
Odor.....	Mild
Flammability (ASTM - MNL #9).....	Non-Flammable
Flash Point (ASTM - MNL #9).....	None
Effect of freezing (While In Liquid Storage State).....	Damaging
Storage life.....	One Year
Cone Penetration @ 77° F.(ASTM D-217).....	Passes
<b>Wear/Scrub Resistance (D-2486 - Modified)</b>	
Unconditioned 6,000 cycles minimum.....	Passes
Conditioned 4,000 cycles minimum.....	Passes
Wet track abrasion test (ISSA TB#100 ASTM D 3910.6.4).....	15.9 gm. per sq. ft.

**SOURCES:** AASHTO (American Assoc. of State and Highway Officials).  
ASTM (American Society of Testing Methods).  
ISSA (International Slurry Seal Association).

**PACKAGING:** 5 Gallon Pails, 55 Gallon Drums & Bulk Deliveries

**FOOTNOTES:** The following is a general endorsement from the 'Asphalt Institute' regarding asphalt sealing technology: *"If one does not seal, fine hair line cracks appear in the pavements surface...and this is the start of a maintenance problem... By sealing we then extend the life of the pavements... if one seals immediately, and providing other variables that lead to pavement failure do not come into play, you should be able to extend the pavement life almost indefinitely..."*(Excerpt from letter by Carl W. Lubold, Jr., District Engineer, for the Asphalt Institute.)



**ARMOR SEAL**

# SAFETY DATA SHEET

## Armorseal A-100; Armorseal A-100 HD

### Section 1: IDENTIFICATION

**Product Identifier** : Armorseal A-100; Armorseal A-100 HD  
Asphalt sealcoat; asphalt sealer

**Manufacturer** : Cascade Asphalt Sealing Company  
6238 South Tacoma Way  
Tacoma, Washington 98409-4126

**Recommended Use** : Used to seal and prolong the life of asphalt parking lots

**Telephone Numbers** : Emergency Telephone : Chemtrec 1-800-424-9300  
Product Information : (800) 846-9125

### Section 2: HAZARDS IDENTIFICATION

#### EMERGENCY OVERVIEW

**- MAY CAUSE SKIN AND RESPIRATORY TRACT IRRITATION**

#### GHS Classification of the Substance or Mixture

**Pictogram** : **Signal Word - Warning !**



**Hazard Statements** : H316 Causes mild skin irritation - Category 3  
H303 May be harmful if swallowed  
H320 Causes eye irritation - Category 2B  
H333 May be harmful if inhaled - Category 5  
H335 May cause respiratory irritation - Category 3  
H351 Suspected of causing cancer - Category 2

**Risk Phrases** : R36/37/38 Irritating to eyes, respiratory system, and skin

**Precautionary Statement** : P260 Do not breathe dust/fume/gas/mist/vapors/spray  
P264 Wash hands thoroughly after handling  
P271 Use only in a well ventilated area  
P280 Wear protective gloves/protective clothing/eye protection/face protection

**Safety Phrases** : S24/25 Avoid contact with skin and eyes  
S36 Wear suitable protective clothing  
S37/39 Wear suitable gloves and eye/face protection  
S45 In case of accident or if you feel unwell, seek medical advice immediately

# SAFETY DATA SHEET

## Armorseal A-100; Armorseal A-100 HD

### Health Hazards or Risks From Exposure:

#### ACUTE

- Eye** : Contact may cause mild irritation including stinging, watering and redness.
- Skin** : Contact may cause mild to moderate skin irritation. Prolonged or repeated contact may worsen irritation by causing drying and cracking of the skin leading to dermatitis (inflammation). Long-term skin exposure can increase sensitivity to the sun and cause discoloration. No harmful effects from skin absorption are expected.
- Inhalation** : Vapor or fumes from this material may cause respiratory irritation. Symptoms of respiratory irritation may include coughing and difficulty breathing.
- Ingestion** : Ingestion may cause stomach discomfort.
- Delayed or Other Health Effects** : May cause cancer

### Section 3: COMPOSITION/INFORMATION ON INGREDIENTS

Component	CAS #	Weight %
Asphalt Emulsion Base (Asphalt 100%)	8052-42-4	25-35 %
Slate, Crushed (Crystalline Silica 30-50%)	14808-60-7	25-35 %
Suspension Agent (Clay >95%; Crystalline Silica <3%)	63800-37-3 14808-60-7	2.5-7.5 %
Balance Water	7732-18-5	25-40 %
Proprietary components present at less than 1% each		

### Section 4: FIRST-AID MEASURES

- Eyes** : If irritation or redness develops from exposure to fumes, move victim away from exposure and into fresh air. Remove contact lenses. For contact with the material, hold eyelids apart and flush eyes with plenty of water for at least 15 minutes.
- Skin** : Wear protective gloves to minimize skin contamination. To remove the material from skin, apply a waterless hand cleaner, mineral oil, or petroleum jelly. Then wash with soap and water. As a precaution, remove clothing and shoes if contaminated. Discard contaminated clothing or thoroughly clean before reuse.
- Ingestion** : Do not induce vomiting due to danger of aspirating liquid into lungs. Gastric lavage may be required. Never give anything by mouth to an unconscious person. As a precaution, get medical advice.
- Inhalation** : If respiratory symptoms develop from exposure to fumes, move victim away from source of exposure and into fresh air. If not breathing, give artificial respiration. If breathing is difficult, get medical attention as soon as possible.

### Section 5: FIRE-FIGHTING MEASURES

**Fire Classification** : Not a flammable or combustible liquid

**NFPA Rating System** : Health: 1

Flammability: No Data Available

Reactivity: 0

Effective Date: 9/10/15

# SAFETY DATA SHEET

## Armorseal A-100; Armorseal A-100 HD

- Extinguishing Media** : Dry chemical, carbon dioxide, water fog or foam.
- Specific Hazards** : In a fire, hazardous fumes, decomposition products or residues may be produced. Combustion products may include: carbon monoxide, carbon dioxide and oxides of nitrogen and sulfur. Burning of product may release hydrogen sulfide gas.
- Protective Equipment or Precautions** : This material will burn although it is not easily ignited. For fires involving this material, do not enter any enclosed or confined fire space without proper protective equipment, including self-contained breathing apparatus.

### Section 6: ACCIDENTAL RELEASE MEASURES

- Personal Precautions** : Ensure adequate ventilation. Avoid contact with skin, eyes, and clothing. Use personal protective equipment.
- Protective Measures** : Eliminate all sources of ignition in vicinity of spilled material.
- Spill Management** : Stop source of release if you can do it without risk. Contain release to prevent further contamination of soil, surface water or groundwater. Clean up spill as soon as possible.
- Methods for Cleaning Up** : Dam up. Absorb with inert material. Pick up and transfer to properly labeled containers. Clean contaminated surface thoroughly.

### Section 7: HANDLING AND STORAGE

- Handling** : Handle in accordance with good industrial hygiene and safety practices. Do not eat, drink, or smoke while handling this product. Wash thoroughly after handling. Avoid breathing vapors/mists generated by this product. Use in a well-ventilated location.
- Storage** : Do not use or store near heat, sparks or open flame. Store only in a well ventilated area. Keep container closed when not in use. Do not store container in direct sunlight or above 100 F.
- Incompatible Products**: Strong oxidizing agents. Acids.

### Section 8: EXPOSURE CONTROLS/PERSONAL PROTECTION

#### Exposure Limits/Guidelines:

Chemical Name	ACGIH TLV	OSHA PEL
Asphalt 8052-42-4	TWA: 0.5 mg/m3 (Inhalable)	-
Silica, Crystalline 14808-60-7	0.025 mg/m3 (Respirable)	10 + [% quartz + (% cristobalite x 2) + (% tridymite x 2) + 2] (Respirable)
Clay 63800-37-3	10 mg/m3 (Inhalable)	15 mg/m3 (Total) 5 mg/m3 (Respirable)
Cellulose 9004-34-6	TWA: 10 mg/m3 (Total)	TWA: 15 mg/m3 (Total) TWA 5 mg/m3 (Respirable)

**Engineering Controls** : Use in a well ventilated area. Use process enclosures, local exhaust ventilation, or other engineering controls to control airborne levels below the recommended exposure limits.

#### Personal Protective Equipment:

**Eyes/Face** : Where contact with this material is likely, eye protection is recommended. Use safety glasses

Effective Date: 9/10/15

# SAFETY DATA SHEET

## Armorseal A-100; Armorseal A-100 HD

with side shields. Wear ANSI approved eye protection.

- Skin/Body** : Selection of specific items such as gloves, boots, apron or full-body suit will depend on operation.
- Respiratory** : No protective equipment is needed under normal use conditions. If exposure limits are exceeded or irritation is experienced, NIOSH/MSHA approved respiratory protection should be worn.
- Hygiene Measures** : Handle in accordance with good industrial hygiene and safety practices.

### Section 9: PHYSICAL AND CHEMICAL PROPERTIES

<b>Physical State</b>	: Viscous Liquid
<b>Appearance/Color</b>	: Brown to Black
<b>Odor</b>	: Asphaltic
<b>Odor Threshold</b>	: Mild
<b>pH</b>	: No data available
<b>Melting Point/Freezing Point</b>	: No data available
<b>Boiling Point</b>	: No data available
<b>Flash Point</b>	: No data available
<b>Evaporation Rate</b>	: No data available
<b>Flammability</b>	: No data available
<b>Upper/lower Flammability or Explosive Limits</b>	: No data available
<b>Vapor Pressure</b>	: No data available
<b>Vapor Density</b>	: No data available
<b>Specific Gravity</b>	: No data available
<b>Solubility</b>	: No data available
<b>Auto-Ignition Temperature</b>	: No data available
<b>Decomposition Temperature</b>	: No data available
<b>Viscosity</b>	: No data available

### Section 10: STABILITY AND REACTIVITY

<b>Chemical Stability</b>	: Stable under recommended storage and handling conditions.
<b>Hazardous Decomposition Products</b>	: Carbon Monoxide, Carbon Dioxide, Nitrogen Dioxide. Heating may produce Hydrogen Sulfide.
<b>Possibility of Hazardous Reactions</b>	: None under normal processing.
<b>Incompatibility</b>	: Strong oxidizing agents. Acids.
<b>Hazardous Polymerization</b>	: Hazardous polymerization will not occur.
<b>Conditions to Avoid</b>	: Avoid extreme temperatures.

### Section 11: TOXICOLOGICAL INFORMATION

**Toxicity Data** : Toxicity data is not available for mixture

Chemical Name	LD50 Oral (Rat)	LD50 Dermal (Rat)	LC50 Inhalation (Rat)
Asphalt 8052-42-4	5001 mg/kg	2001 mg/kg	-
Silica, Crystalline	ND	ND	ND

Effective Date: 9/10/15



# SAFETY DATA SHEET

## Armorseal A-100; Armorseal A-100 HD

Chemical Name	LD50 Oral (Rat)	LD50 Dermal (Rat)	LC50 Inhalation (Rat)
14808-60-7			
Clay 63800-37-3	ND	ND	ND
Cellulose 9004-34-6	ND	ND	5800 mg/m <sup>3</sup> 4 Hr Rat

**Carcinogenicity** : Suspected Cancer Agent. Product may contain an ingredient(s) that is found on one or more of the following lists:

Chemical Name	ACGIH	IARC	NTP	OSHA
Asphalt	A3	Group 2B	Reasonably Anticipated	X

ACGIH (American Conference of Governmental Industrial Hygienists) A3 - Animal Carcinogen  
 IRAC (International Agency for Research on Cancer) Group 2B - Possibly Carcinogenic to Humans  
 NTP (National Toxicity Program) Reasonable Anticipated - Reasonably Anticipated to be a Human Carcinogen  
 OSHA (Occupational Safety & Health Administration) X-Carcinogen

### Section 12: ECOLOGICAL INFORMATION

- Ecotoxicity** : This material may be toxic to aquatic organisms and should be kept out of sewage and drainage systems and all bodies of water. The environmental impact of this product has not been fully investigated.
- Bioaccumulation** : This product is estimated to have a slow rate of biodegradation. This product is not expected to bioaccumulate through food chains in the environment.
- Other Adverse Effects** : No information available.

### Section 13: DISPOSAL CONSIDERATIONS

- Waste Disposal** : Dispose of waste according to local, state/provincial, and federal requirements. Avoid disposal into wastewater treatment facilities.
- Contaminated Materials** : Treat as product waste.
- Container Disposal** : Do not re-use empty containers.

### Section 14: TRANSPORTATION INFORMATION

**DOT** : Not Regulated as a hazardous material for transport

### Section 15: REGULATORY INFORMATION

**SARA 311/312 Categories** :

Acute Health Hazard	No
Chronic Health Hazard	No
Fire Hazard	No
Sudden Release of Pressure Hazard	No
Reactive Hazard	No

### Section 16: OTHER INFORMATION

This SDS is intended solely for safety education and not for use as specifications or warranties. The information in this SDS was obtained from usually reliable sources and is provided without any representation for warranties regarding the accuracy



# **SAFETY DATA SHEET**

## **Armorseal A-100; Armorseal A-100 HD**

or correctness. Since the handling, use, and storage is beyond our control, Cascade Asphalt Sealing Company assumes no responsibility and disclaims liability for any loss, damage, or expense arising therefrom.

### **ABBREVIATIONS:**

ACGIH	American Conference of Governmental Industrial Hygienists
ANSI	American National Standards Institute
CAS	Chemical Abstract Services (identifies specific chemical)
CO	Carbon Monoxide
DOT	Department of Transportation
EPA	Environmental Protection Agency
GHS	Globally Harmonized System of Classification and Labeling of Chemicals
IARC	International Agency for Research on Cancer
IDLH	Immediately dangerous to life or health
LC50	Lethal concentration - the concentration of a material in air which causes the death of 50% (one half) of a group of test animals
LD50	Lethal dose - the amount of a material, given all at once, which causes the death of 50% (one half) of a group of test animals
mg/m <sup>3</sup>	Milligrams per cubic meter
mg/kg	Milligrams per kilogram
MSHA	Mine Safety Health Act
NA	Not applicable
ND	Not determined
NFPA	National Fire Protection Association
NIOSH	National Institute of Occupational Safety and Health
NTP	National Toxicology Program
OSHA	Occupational Safety and Health Administration
PEL	OSHA Permissible Exposure Limit
ppm	Parts per million
SARA	Superfund Amendments and Reauthorization Act (US EPA)
SDS	Safety Data Sheet
TLV	Threshold Limit Value
TWA	8-hour time-weighted average exposure

Note: Cascade Asphalt Sealing Company periodically updates and revises its product information. To verify this information, please call the number listed in Section 1.

## **ACTION ITEM – B**

---

**DATE:** July 30, 2020  
**RE:** Office Copier Equipment-Service and Supply Contract  
**TO:** Honorable Board President and Harbor District Board Members  
**ISSUED BY:** Gary Dehlinger, Port Manager

---

### **OVERVIEW**

- At Regular Meeting July 21, 2020, the Board of Commissioners approved the Cannon IRA C556013. Staff found out after the meeting the copier did not have the folding option used by staff extensively.
- Port received revised quotes and a different supplier provided a better quote.
- Staff is recommending the copier Ricoh IM C6000 with optional external paper deck.

### **DOCUMENTS**

- Procurement Request with Quotes, 6 pages

### **COMMISSIONERS ACTION**

- **Recommended Motion:**  
Motion to approve Pacific Office Automation 63-month lease agreement for a Ricoh IM C6000 with external paper deck copier for the Port Office.





# Equipment/Service and Supply Contract

No. \_\_\_\_\_

**SOLD TO:**

Port of Brookings Harbor  
 CUSTOMER NAME  
 16330 Lower Harbor Road  
 BILLING ADDRESS  
 Brookings OR 97415  
 CITY STATE ZIP  
 ( 541 ) - 469 - 2218  
 TELEPHONE  
 Brent Ferguson  
 ATTENTION

**SHIP TO:**

Port of Brookings Harbor  
 CUSTOMER NAME  
 Same as Billing  
 SHIPPING ADDRESS  
 CITY STATE ZIP  
 ( )  
 TELEPHONE  
 KEY OPERATOR

ORDER DATE		PO#		ORDERED BY		SOLD BY	
07/28/2020				Brent Ferguson		Bush	
QTY	ITEM	TYPE	DESCRIPTION			UNIT PRICE	TOTAL
1	New	6000	Ricoh IM C6000			To Be	Leased
			Color Copy, Print, and Scan				
			(4) 550-Sheet Trays + (1) 100-Sheet Bypass				
			220-Sheet Duplexing Document Feeder				
			External Staple, Hole-Punch, and Folding Finisher				
			1200 x 1200 Standard dpi Resolution				
			- Service Includes all Parts, Labor, Toner, Etc....Excluding Paper and Staples				
			- Includes Delivery, Installation, Set-Up, and Networking				
Minimum Monthly Payment (plus applicable taxes) \$ 212.20						Term	63 Months
Service/Supply Agreement	Monthly Base Images	Monthly Base Charges	Overages	Overages Billing Cycle	Term of Contract	Device Management	
B&W Images	2,000	\$0.005	\$0.005	<input checked="" type="checkbox"/> Monthly <input type="checkbox"/> Quarterly <input type="checkbox"/> Semi-Annual <input type="checkbox"/> Annual	<input checked="" type="checkbox"/> 60 months <input type="checkbox"/> 48 months <input type="checkbox"/> 39 months <input type="checkbox"/> 36 months <input type="checkbox"/> Other _____	Automated Meter Reading	
Color Images	2,000	\$0.038	\$0.038			Auto Toner Replenishment	
						Advanced Scanning	
						Security	
						MFP Network Support	
						Power Filter	
CONDITIONS OF SALE, CONTINGENCIES OR COMMENTS						Delivery	Included
- POA to Pick-Up and Ship Back Current Xerox Machine at No Cost to Port of Brookings Harbor. Only Thing Customer is Responsible For is RMA						Subtotal	
- After Install, POA to Wait 1 Week to Execute Lease for Trial Period						Sales Tax	
- Port of Brookings Harbor to Have Option to Add External Paper Deck at Any Point Throughout Lease for \$11/Month						Total	

By signing this Contract, Customer acknowledges and agrees: (a) this Contract is NON-CANCELABLE; (b) all terms and conditions on the reverse side are an integral part of this Contract; (c) to fully understand all terms and conditions stated herein; and (d) this Contract is the entire Agreement between Customer and Pacific Office Automation relating to the equipment and services described herein, and can be changed only by written agreement signed by both parties.

Customer Authorization

Approved by Pacific Office Automation

\_\_\_\_\_  
 SIGNATURE  
 \_\_\_\_\_  
 TITLE DATE

\_\_\_\_\_  
 BY  
 \_\_\_\_\_  
 TITLE DATE

## SERVICE/SUPPLY AGREEMENT TERMS AND CONDITIONS

As consideration for Customer's payment as set forth on the front of the Contract, Pacific Office Automation ("POA") agrees to provide the listed supplies, parts and labor service for the covered equipment pursuant to the terms and conditions contained herein.

- Replacement of all parts found defective or worn as a result of normal equipment use.
- Labor to repair and properly maintain the equipment.
- All preventative maintenance done at intervals specified by the manufacturer.
- Loaner equipment in the event the equipment requires shop work to repair.
- Replacement of photoconductors and heater rollers found defective or worn as a result of normal use.
- Replacement of black and color toner, black developer, brushes, and filters.
- Factory recommended retrofits and improvements in the equipment.

If color toner is included in the Service/Supply Agreement, the color toner will be supplied within the cost per copy charge based upon the standard manufacturer's yield. Excess toner will be billed at standard manufacturer's retail price. Not included in the Service/Supply Agreement are paper, staples, and network support. Service calls by POA covered under the Service/Supply Agreement will only be made during the hours of 8 a.m. to 5 p.m., Monday through Friday, excluding holidays. Service billed at any other time will be billed at standard overtime rates. For products or services acquired hereunder, the terms of payment are net ten (10) days.

Customer agrees to pay POA the base and overage charges agreed to on the front of the Contract and agrees that excess images over the allotted base amount during the billing cycle will be billed to Customer at the agreed to rate for overages. If not noted, overages will be charged at POA's book rates. If the Service/Supply Agreement combines two or more pieces of equipment of different operating costs, POA reserves the right to adjust image allocation and pricing to fairly reflect actual usage should the actual usage rate of the equipment vary by more than 10% from the expected usage rates. Customer agrees that POA may increase the per image charge each year during any term of the Service/Supply Agreement by an amount not to exceed 10% of such charge. Service may include reasonable use of Customer's image allotments and materials. Customer's failure to abide by all payment obligations may result in termination of service.

This Service/Supply Agreement shall continue for the term stated on the front of the Contract. The Service/Supply Agreement shall automatically renew for successive one (1) year terms, unless either party provides written notice to the other party of their intent to terminate prior to thirty (30) days before the expiration of the original term or any subsequent renewal term.

## GUARANTEES

POA extends to Customer the following express limited guarantees under the Service/Supply Agreement.

- 1. STANDARD LIMITED WARRANTY:** POA warrants equipment to be free of defect in materials and workmanship for a period of 90 days from installation. This warranty does not extend to replacement of supply items or consumables, including, but not limited to photo conductors, heater rollers, fuser, cleaning kits, toner, developer, or paper. For purposes of this paragraph, New equipment shall be defined as equipment with usage up to 5,000 copies. Used equipment will receive a 30-day warranty.
- 2. LIFETIME POWER PROTECTION GUARANTEE:** If a POA Power Filter is included in the Service/Supply Agreement, repairs of damage to covered equipment caused by power surges and/or lightning will be covered.
- 3. RESPONSE TIME WARRANTY:** POA guarantees four New hour average response time for emergency services for equipment that is within fifty miles of POA branch offices. If POA does not perform guaranteed response time for a period of one year, upon written request, Customer will receive a 5% credit towards Customer's next service or supply purchase from POA.
- 4. UPGRADE, TRADE-IN LIMITED GUARANTEE:** For all New equipment purchased hereunder continuously covered under a POA Service/Supply Agreement, POA will guarantee a trade-in value on New equipment sold by POA up to 90% during the first 36 months after acquisition and a minimum guaranteed trade-in value of 10% thereafter.

## GENERAL TERMS & CONDITIONS

(1) Unless provided, the terms of sale are ten (10) days net. POA agrees to provide reasonable assistance to Customer in its efforts to finance the purchase or lease of the equipment and/or Service/Supply Agreement; however, Customer understands and acknowledges such financing cannot be guaranteed by POA. Customer shall be ultimately responsible for payment of the purchase price of equipment sold or leased. If not provided, the purchase price is the Manufacturer's Suggested Retail Price of the equipment and/or solutions plus the cost of any lease buyouts, delivery charges, installation charges, and the total Service/Supply Agreement.

(2) If customer defaults in the payment of the purchase price or any other obligation as provided herein, Customer agrees to pay to POA a service charge of 1.5% per month and all of POA's related attorney's fees and collection costs, even if no suit or action is filed. This Contract shall be governed by the internal laws of the State of Oregon. Customer hereby submits and consents to jurisdiction and venue in Multnomah County, Oregon.

(3) The sales price herein includes the initial installation of the manufacturer's software onto Customer's computers. Prior to such installation, Customer shall perform and complete a system backup. POA shall not be liable for loss or damage of any kind to data or equipment as a result of the installation of the manufacturer's software. Customer shall be solely responsible for the cost of any cables or additional hardware required to connect equipment to a network. POA shall not be responsible for any updates or problems arising after the initial installation due to a change in the Customer's computers and/or Network.

(4) POA MFP Network Service solely provides coverage for services related to the connectivity between the covered equipment and the Customer's Network. MFP Network Service does not provide coverage for services for the Customer's Network itself.

(5) **DISCLAIMER: EXCEPT AS SPECIFICALLY PROVIDED HEREIN, POA DISCLAIMS ALL WARRANTIES, EXPRESS OR IMPLIED, INCLUDING, WITHOUT LIMITATION, ALL IMPLIED WARRANTIES OF MERCHANTABILITY OR FITNESS FOR A PARTICULAR PURPOSE. EQUIPMENT IS SUBJECT TO A MANUFACTURER'S WARRANTY. UNDER NO CIRCUMSTANCES WILL POA BE RESPONSIBLE FOR ANY CONSEQUENTIAL OR INCIDENTAL DAMAGES.**

(6) Customer shall make arrangements to protect or remove sensitive and private data that may become stored on Customer's equipment. While POA may provide options for data removal and protection, Customer is solely responsible for selecting an appropriate data removal standard that meets Customer's business needs. POA is not recommending any particular option, and POA is not liable for damages arising from Customer's failure to fully remove and protect its data. Please note that regardless of which standard Customer chooses, Customer must return leased equipment in full working order at the end of any lease term.

# Port of Brookings

## Revised 7-22-2020

- Canon IRA DX C7765i
- **65 ppm B/W & Color**
- Single Pass Document Feeder
- Network Printing and scanning
- Scan file: PDF, TIFF, Microsoft Word or PowerPoint
- PCL/ Post Script
- 2 – 1,100 sheet paper drawers
- 2 – 550 sheet paper Drawers
- Booklet Stapling Finisher – w/  
**Staple free & Staple on Demand Stapling**
- 2/3 hole punch
- **Document Insertion/Z & C fold**
- UFR II, PCL, & PostScript Drivers
- Network Printing and scanning
- B/W and Color scanning, scan to email or file. Unlimited users
- Searchable PDF, PDF, JPEG , TIFF, Word or PowerPoint.
- Secure print. (Hold or locked print)
- Hard drive lock and erase Encrypted
- Mobile printing included
- USB thumb drive scan or print
- ESP Power Filter
- **Requires 20amp circuit**

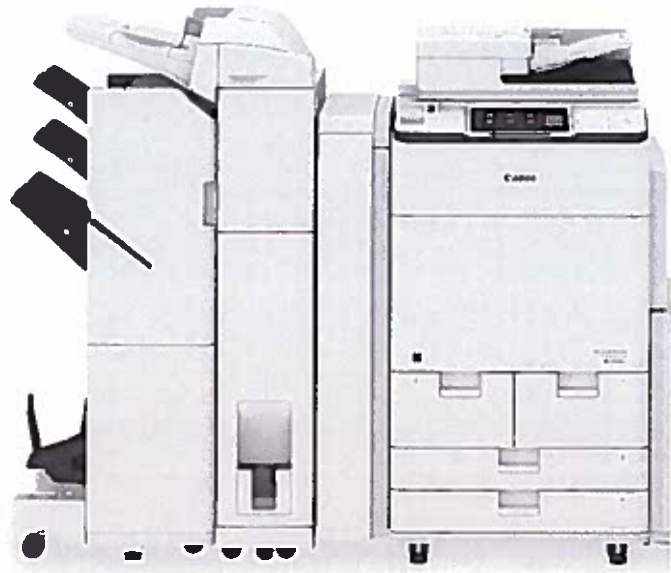

Omnia Partner Contract Pricing:  
FMV Lease – 60 mo.

**Reduced to \$309.05/mo.**  
**By Zone V.P**

Maintenance includes all toner,  
labor, parts and staples.

Service Rates locked for term.

B/W cpc rate @ **\$0.0067/copy**

Color cpc rate @ **\$0.041/copy**

Billed in arrears

**Above figures include buyout of  
\$483.16 x 2 mo. + Return of  
Xerox to lease company**

Steven Forshay  
Territory Account Manager  
458-225-0182

**Canon**

CANON SOLUTIONS AMERICA

# Executive Financial Summary



Port of Brookings Harbor  
 16330 Lower Harbor Rd.  
 Brookings, Oregon 97415

July 08, 2020

Current Equipment										
Current Equipment										
Equipment	Equipment Status	Product Lease & Maint.	Meter	Print Charges Volume Band	Per Print Rate	Average Monthly Volume	Meter Charges	Supplies	Average Monthly Expenses	
W7970P 70 ppm Color Copier/Network Printer/ Scanner/Fax line/BR Booklet Maker- Vfold- Saddle Stitch-Stapler- Slacker- 2/3 hole punch/Z/C Folder S/N B0W592355	Leased 57 of 60	\$483.16	1. BW 2. CLR	0 0	\$0.007 \$0.0706	5,262 3,574	\$36.83 \$252.32	Included	\$772.31	
<b>Total C8170</b>		<b>\$483.16</b>					<b>\$289.15</b>		<b>\$772.31</b>	
Proposed										
Equipment	Lease Term	Lease & Maint.	Meter	Print Charges Volume Band	Per Print Rate	Average Monthly Volume	Meter Charges	Supplies	Average Monthly Expenses	
C8170 70 ppm Color Copier/Network Printer/ 270 ipm single pass scanner (scans both sides in single pass) / BR Booklet Maker- Vfold- Saddle Stitch-Stapler- Slacker- 2/3 hole punch / Z/C Folder	60 Months	\$310.00	1. BW 2. CLR	0 0	\$0.007 \$0.049	5,262 3,574	\$36.83 \$175.13	Included	\$609.96	
<b>Total C8170</b>		<b>\$310.00</b>					<b>\$211.96</b>		<b>\$521.96</b>	

Oregon Office Solutions  
 Proposed by Dave Rogers  
 Phone: 541-815-1777  
 Email: dave@oregonofficesolutions.com

The information contained in this summary was collected from your recent Xerox invoices.  
 Confidential - © 2020 XEROX CORPORATION. All rights reserved.





Brent Ferguson &lt;brent@portofbrookingsharbor.com&gt;

---

**Port of Brookings - Xerox lease term options**

1 message

---

Dave Rogers <dave@oregonofficesolutions.com>  
Reply-To: Dave@oregonofficesolutions.com  
To: Brent Ferguson <brent@portofbrookingsharbor.com>

Thu, Jul 9, 2020 at 10:34 PM

Hi Brent,

Here is the information you requested. I still need to know if you will be using the fax feature with this new device. Regarding your request for more information, monthly lease payments are higher on shorter-term leases. Here's what I have:

- For a 24-month lease - \$661 per month plus cost per copy
- For a 36-month lease - \$440 per month plus cost per copy
- For a 48-month lease - \$372 per month plus cost per copy
- For a 60-month lease - \$310 per month plus cost per copy \*This is the one I proposed to you.

**Note:** the cost per copy for each of these choices is \$0.007 for black & white and \$0.049 for color. Each of these choices includes a Xerox maintenance that covers all parts, service calls, and consumable supplies such as toners, drums, staples – basically everything except the paper! This pricing also includes delivery, set-up, a Xerox Analyst to connect your new device to your office network, training, and the removal of your old Xerox 7970. This C8170 is a brand new machine with advanced ConnectKey features such as apps.

We will deliver the new device and ensure it is networked and working according to the attached CED. At that time, we can order the removal of the old device which takes about 2 weeks. This way we can ensure the new device is performing as promised. If for some reason the new machine doesn't perform according to the CED, Xerox will abort the install and return the device. You would keep your 7970 until the end of its' contract term which I believe is around the 15<sup>th</sup> of this coming September.

Let me know about the fax feature as soon as you can. Thanks, Brent – Dave

Dave Rogers Regional Manager

---

Technology :: Document Management :: Consulting Services

---

Dave@oregonofficesolutions.com / oregonofficesolutions.com

phone: 541.382.0300 / fax: 541.382.0500 / cell: 541.815.1777

Serving Clatsop, Tillamook, Yamhill, Lincoln, Polk, Lane, Douglas,

Coos, Curry, Linn, Benton, Marion, Clackamas, Jefferson,